



Solis RHI Series Hybrid Inverter Instruction Manual

Ver 1.5

Ningbo Ginlong Technologies Co., Ltd.

No. 57 Jintong Road, Binhai Industrial Park, Xiangshan, Ningbo,
Zhejiang, 315712, P.R.China.

Tel: +86 (0)574 6578 1806

Fax: +86 (0)574 6578 1606

Email: info@ginlong.com

Web: www.ginlong.com

Please adhere to the actual products in case of any discrepancies in this user manual.

If you encounter any problem on the inverter, please find out the inverter S/N
and contact us, we will try to respond to your question ASAP.



Ningbo Ginlong Technologies Co., Ltd.

1. Introduction	2
1.1 Product Description	2
1.2 Packaging	3
2. Safety & Warning	4
2.1 Safety	4
2.2 General Safety Instructions	4
2.3 Notice For Use	6
3. Overview	7
3.1 Screen	7
3.2 Keypad	7
3.3 Terminal Connection	7
4. Installation	8
4.1 Select a Location for the Inverter	8
4.2 Mounting the Inverter	10
4.3 PV Input Terminal Assembly	11
4.4 Battery Terminal Components	12
4.5 Assembling the AC Connector	13
4.6 Meter Installation	14
4.7 Communication Cable Assembly	16
4.8 Logic interface connection (Only for UK)	17
4.9 LED Indicates	18
5. Operation	19
5.1 Interface	20
5.2 Information	22
5.3 Settings	23
5.4 Advanced Info	26
5.5 Advanced Settings - Technicians Only	32
6. Commissioning	48
6.1 Preparation of Commissioning	48
6.2 Commissioning Procedure	48
7. Troubleshooting	49
8. Maintenance	55
9. Appendix	61

1. Introduction

1.1 Product Description

The Solis RHI series is designed for residential hybrid systems, which can work with batteries to optimize self-consumption. The unit can operate in both off- and on-grid modes.

The Solis RHI series has 4 different models:

RHI-3K-48ES , RHI-3.6K-48ES , RHI-4.6K-48ES , RHI-5K-48ES

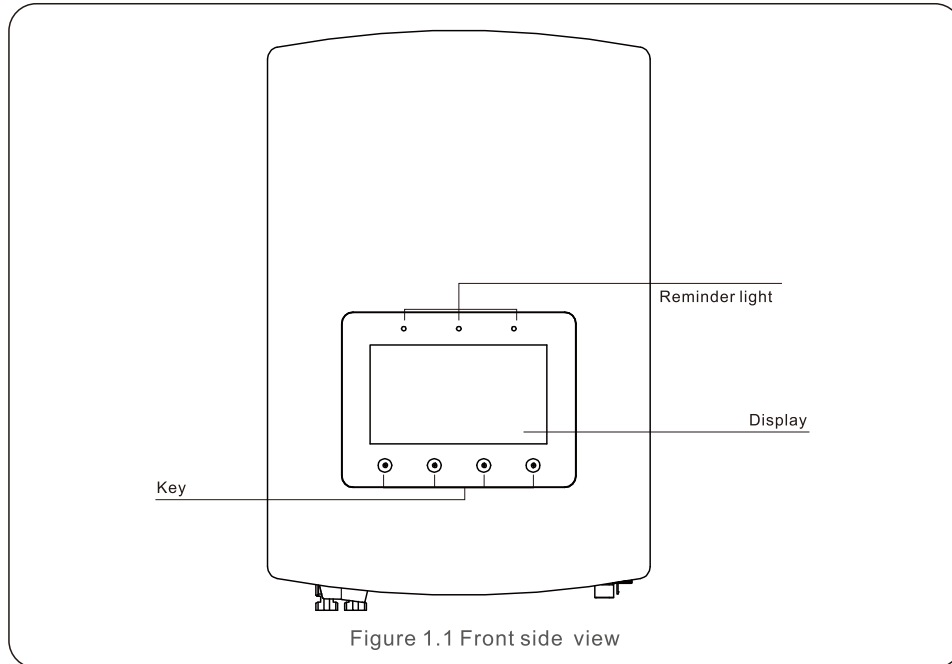

Figure 1.1 Front side view

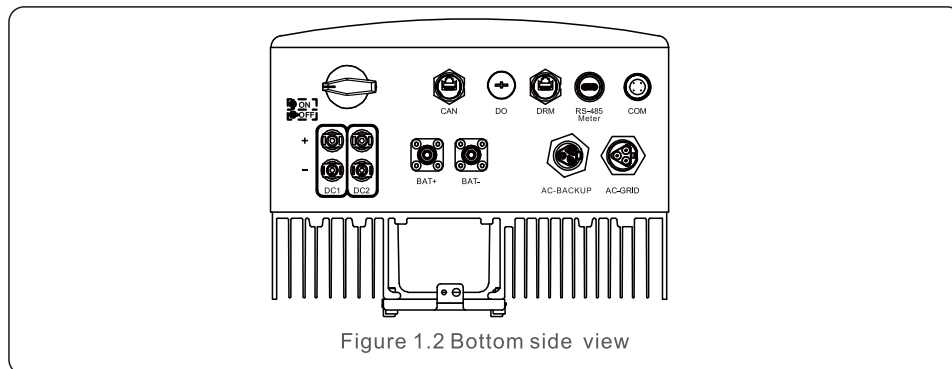
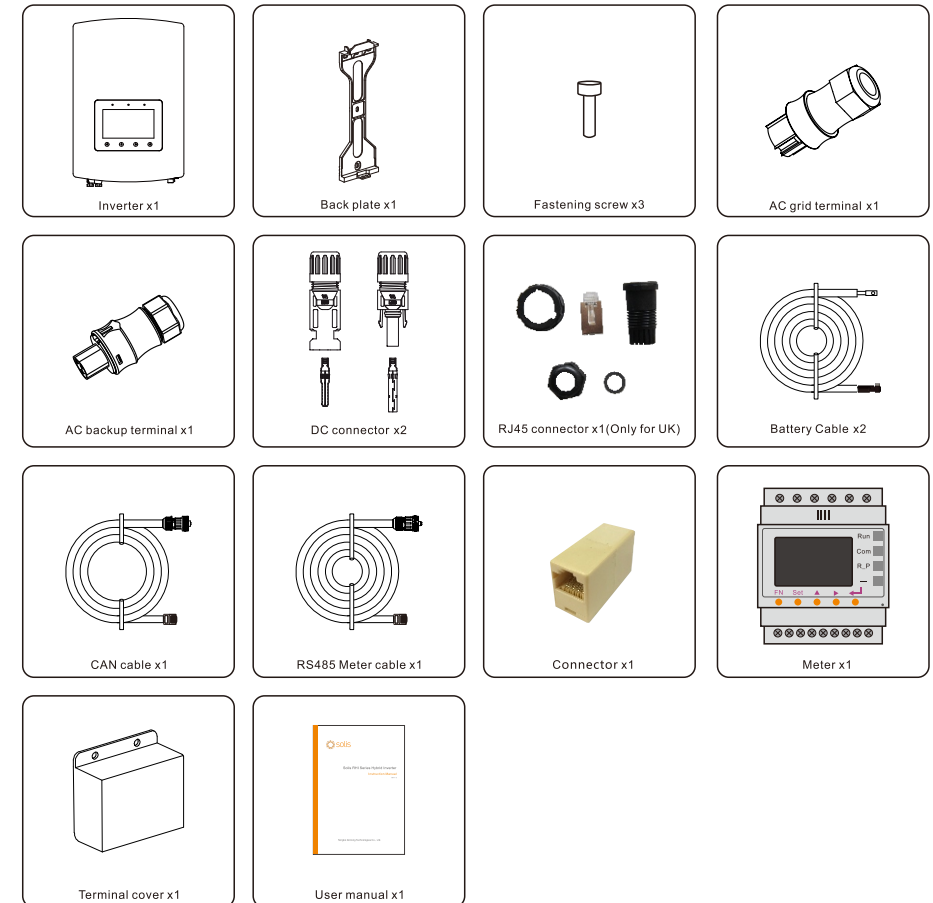

Figure 1.2 Bottom side view

1. Introduction

1.2 Packaging

Please ensure that the following items are included in the packaging with your machine:



If anything is missing, please contact your local Solis distributor.

2. Safety & Warning

2.1 Safety

The following types of safety instructions and general information appear in this document as described below:



DANGER:

“Danger” indicates a hazardous situation which if not avoided, will result in death or serious injury.



WARNING:

“Warning” indicates a hazardous situation which if not avoided, could result in death or serious injury.



CAUTION:

“Caution” indicates a hazardous situation which if not avoided, could result in minor or moderate injury.



NOTE:

“Note” provides tips that are valuable for the optimal operation of your product.

2.2 General Safety Instructions



WARNING:

Only devices in compliance with SELV (EN 69050) may be connected to the RS485 and USB interfaces.



WARNING:

Please don't connect PV array positive (+) or negative (-) to ground, it could cause serious damage to the inverter.



WARNING:

Electrical installations must be done in accordance with the local and national electrical safety standards.



WARNING:

Do not touch any inner live parts until 5 minutes after disconnection from the utility grid and the PV input.

2. Safety & Warning



WARNING:

To reduce the risk of fire, over-current protective devices (OCPD) are required for circuits connected to the inverter. The DC OCPD shall be installed per local requirements. All photovoltaic source and output circuit conductors shall have isolators that comply with the NEC Article 690, Part II. All Solis single phase inverters feature an integrated DC switch.



CAUTION:

Risk of electric shock, do not remove cover. There is no user serviceable parts inside, refer servicing to qualified and accredited service technicians.



CAUTION:

The PV array supplies a DC voltage when they are exposed to sunlight.



CAUTION:

Risk of electric shock from energy stored in capacitors of the Inverter, do not remove cover for 5 minutes after disconnecting all power sources (service technician only). Warranty may be voided if the cover is removed without authorization.



CAUTION:

The surface temperature of the inverter can reach up to 75°C (167 F). To avoid risk of burns, do not touch the surface of the inverter while it's operating. Inverter must be installed out of the reach of children.



NOTE:

PV module used with inverter must have an IEC 61730 Class A rating.



WARNING:

Operations below must be accomplished by licensed technician or Solis authorized person.



WARNING:

Operator must put on the technicians' gloves during the whole process in case of any electrical hazards.



WARNING:

AC-BACKUP of RHI series is forbidden to connect to the grid.

2. Safety & Warning



WARNING:

The RHI series does not support parallel (three- and single-phase) operation on the AC-BACKUP port. Parallel operation of the unit will void the warranty.

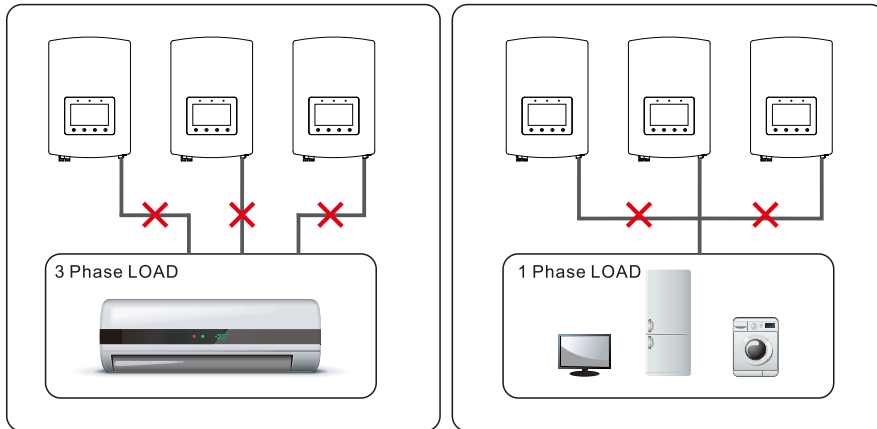

WARNING:

Please refer to the specification of the battery before configuration.

2.3 Notice For Use

The inverter has been constructed according to the applicable safety and technical guidelines. Use the inverter in installations that meet the following specifications ONLY:

1. Permanent installation is required.
2. The electrical installation must meet all the applicable regulations and standards.
3. The inverter must be installed according to the instructions stated in this manual.
4. The inverter must be installed according to the correct technical specifications.

3. Overview

3.1 Screen

Solis RHI series adopts 7 inch color screen, it displays the status, operating information and settings of the inverter.

3.2 Keypad

There are four keys in the front panel of the inverter (from left to right): ESC, UP, DOWN and ENTER keys. The keypad is used for:

- Scrolling through the displayed options (the UP and DOWN keys);
- Access and modify the settings (the ESC and ENTER keys).



Figure 3.2 Keypad

3.3 Terminal Connection

Solis RHI series inverter is different from normal on-grid inverter, please refer to the instructions below before start connection.

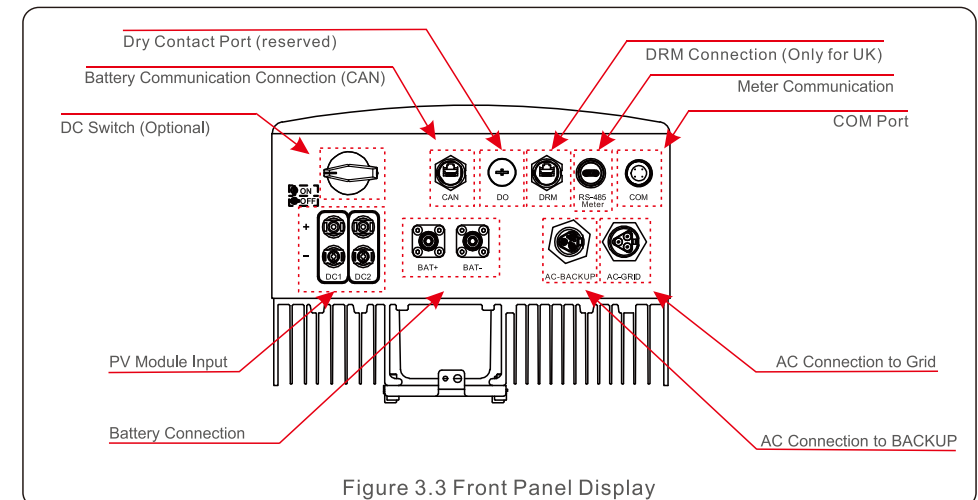

Figure 3.3 Front Panel Display



WARNING:

Please refer to the specification of the battery before configuration.

4. Installation

4.1 Select a Location for the Inverter

To select a location for the inverter, the following criteria should be considered:

- Exposure to direct sunlight may cause output power derating. It is recommended to avoid installing the inverter in direct sunlight.
- It is recommended that the inverter is installed in a cooler ambient which doesn't exceed 104F/40C.

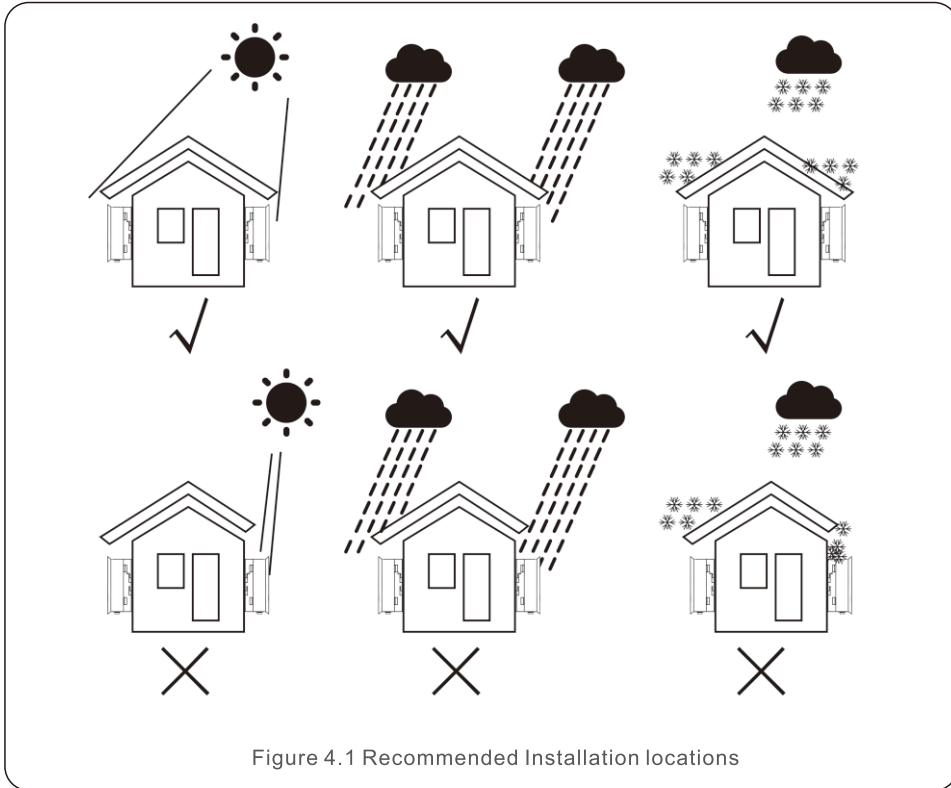

4. Installation

- Install on a wall or strong structure capable of bearing the weight of the machine (17kg).
- Install vertically with a maximum incline of +/- 5 degrees, exceeding this may cause output power derating.
- To avoid overheating, always make sure the flow of air around the inverter is not blocked. A minimum clearance of 300mm should be kept between inverters or objects and 500mm clearance between the bottom of the machine and the ground.

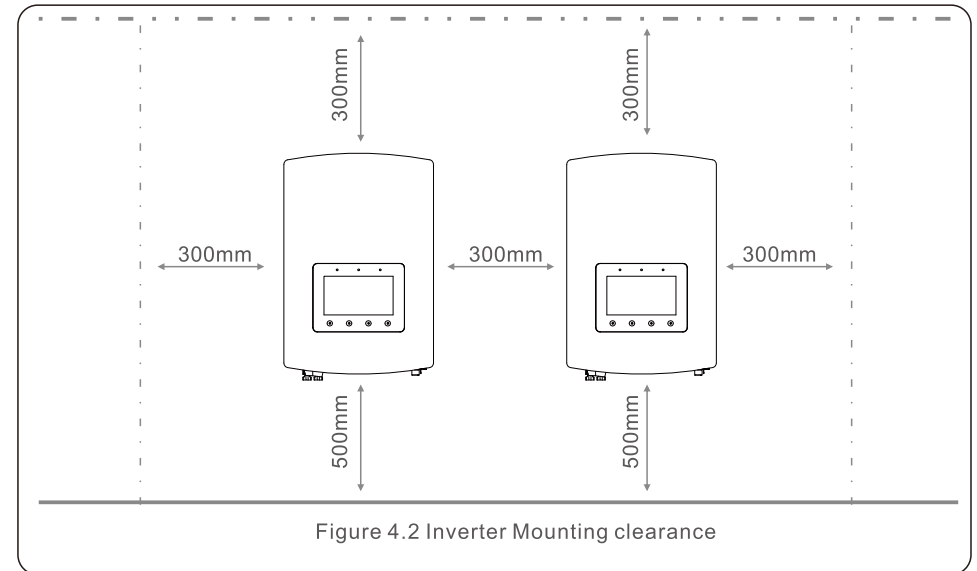

- Visibility of the LEDs and LCD should be considered.
- Adequate ventilation must be provided.



NOTE:

Nothing should be stored on or placed against the inverter.

4. Installation

4.2 Mounting the Inverter

Dimensions of mounting bracket:

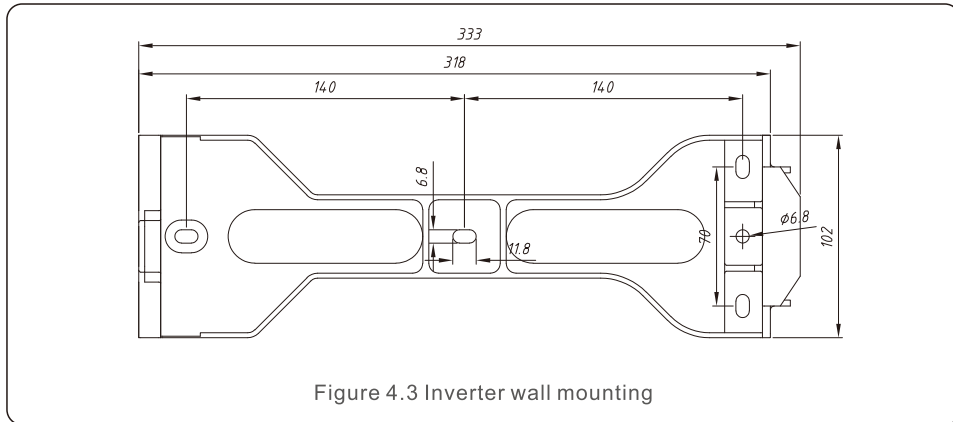

Once a suitable location has been found accordingly to 4.1 using figure 4.3 and figure 4.4 mount the wall bracket to the wall.

The inverter shall be mounted vertically.

The steps to mount the inverter are listed below:

1. Select the mounting height of the bracket and mark the mounting holes.
For brick walls, the position of the holes should be suitable for the expansion bolts.

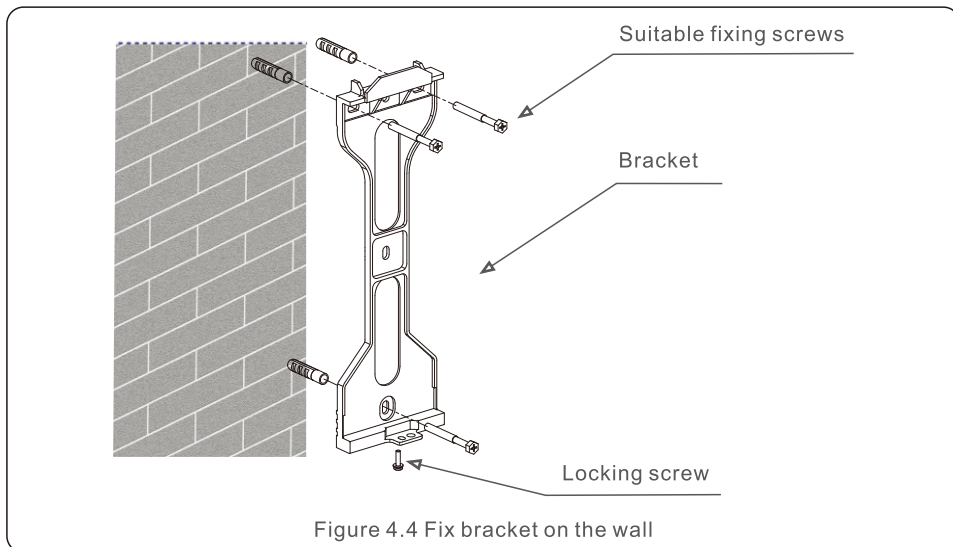

4. Installation



WARNING:

The inverter must be mounted vertically.

2. Lift up the inverter (be careful to avoid body strain), and align the back bracket on the inverter with the convex section of the mounting bracket. Hang the inverter on the mounting bracket and make sure the inverter is secure (see Figure 4.5)

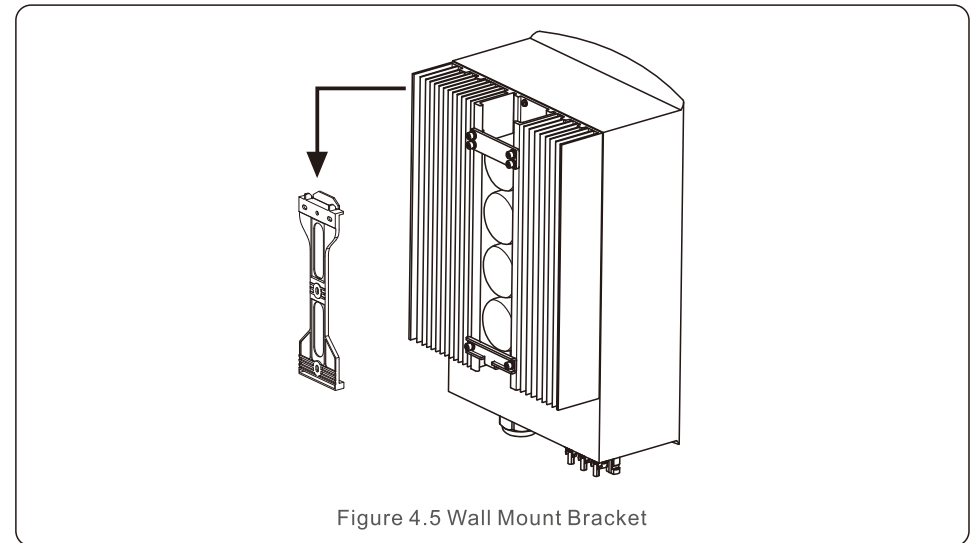

4.3 PV Input Terminal Assembly

Please ensure the following before connecting the inverter:

- Make sure the voltage of the PV string will not exceed the max DC input voltage (600Vdc).
Violating this condition will void the warranty.
- Make sure the polarity of the PV connectors are correct.
- Make sure the DC-switch, battery, AC-BACKUP, and AC-Grid are all in their off-states.
- Make sure the PV resistance to ground is higher than 20K ohms.

The Solis RHI series inverter uses the MC4 connectors. Please follow the picture below to assemble the MC4 connectors.

PV wire diameter requirements: 2.5~4mm².

4. Installation

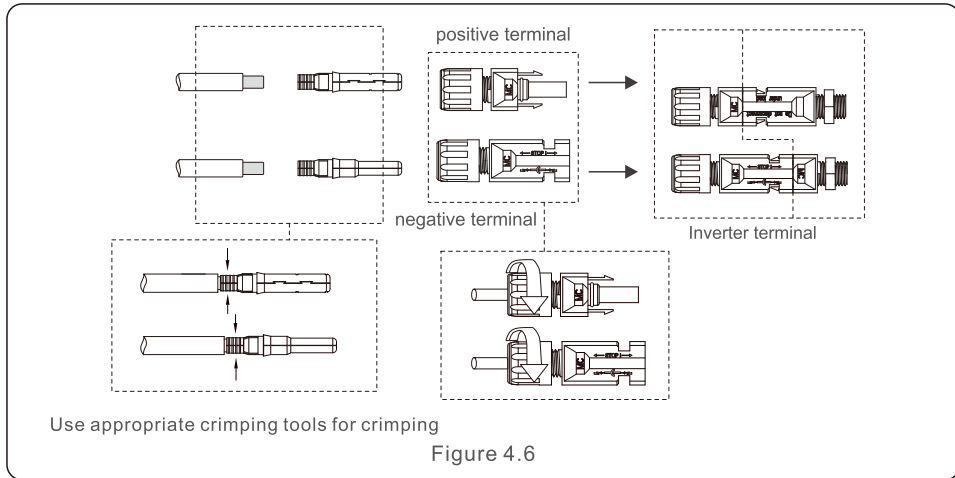

4.4 Battery Terminal Components

To avoid DC Arc, Solis recommends installing DC switch between batteries and Hybrid Inverter. (At least 65A)

- Ensure the correct polarity of batteries before connecting to the inverter.



WARNING:

Power cables use water-proof AMPHENOL connectors. When pull out the power cable, you must press the button as indicated in the right figure.

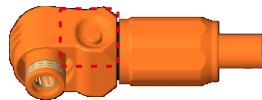

Connect the Battery cable to the inverter and make sure the positive and negative poles are correct. A "Click" sound means fully connection and fasten the cables with the terminal protection cover as indicated in Figure 4.7.

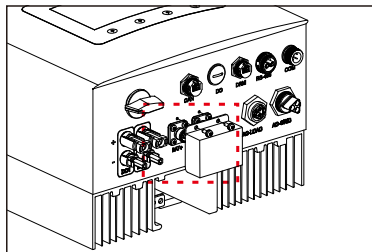

Figure 4.7 Installation of Terminal Protection Cover

4. Installation

4.5 Assembling the AC Connector

There are two AC terminals and the assembly steps for both are the same.

Take out the AC connector parts from the packaging.

1. Make sure you use a cable within the correct specifications as shown in the image below.

Describe	Numerical value
Wire diameter	10~12mm
Traverse cross sectional area	2.5~6mm ²
Exposure Length	12mm

2. Lead the AC cable through the cable gland and the housing.

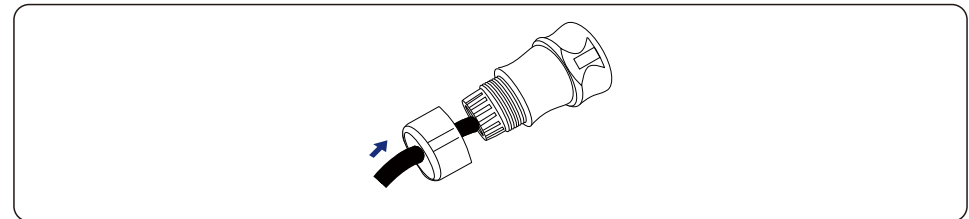

3. Remove a length of 40mm of the cable jacket and strip the wire insulation to a length of 8 – 15mm.

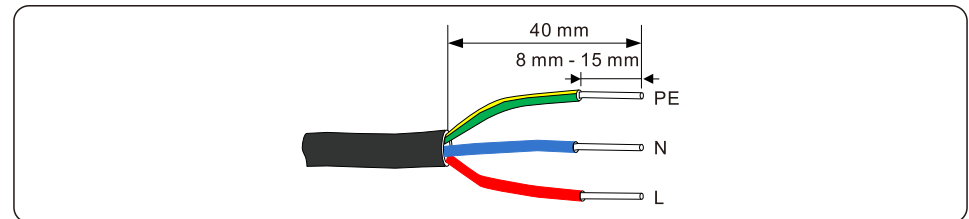

4. Each of the terminals are labeled. Ensure that the correct conductor is fastened (1.2 N.m. torque) to the correct terminal.

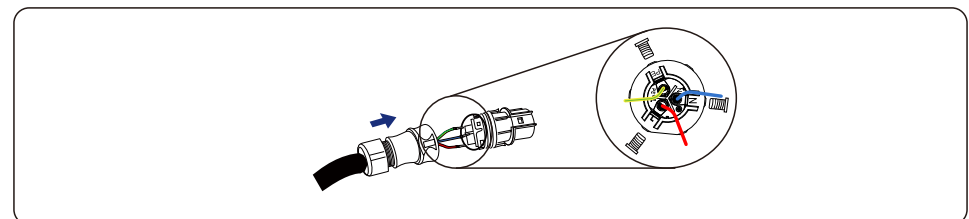

4. Installation



WARNING:

Observe the terminal layout of terminal block.
Do not connect the phase lines to "PE" terminal, otherwise the inverter will not function properly.

5. Make sure the rib of the terminal block and the groove on the housing engage perfectly until a "click" is heard to felt.

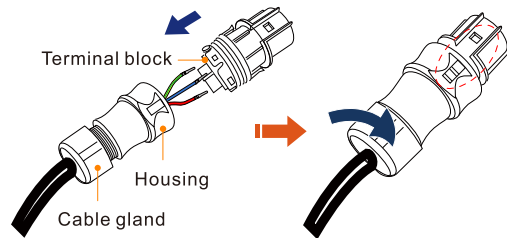

4.6 Meter Installation

Solis RHI-(3-5)K-48ES series inverter integrated export power control function, this function need connect a single phase or 3-Phase power meter for export power controlling.

When use the single phase meter , please set meter model to " 1Ph Meter" , when use 3-Phase meter, please set meter model to " 3Ph Meter". (refer 5.5.6.3)

4.6.1 Single phase meter installation

Follow the image below to install the single phase Meter and CT clamp. The voltage connections for the meter must be connected to pins 1 and 4. The CT clamp is labeled for correct orientation.

4. Installation

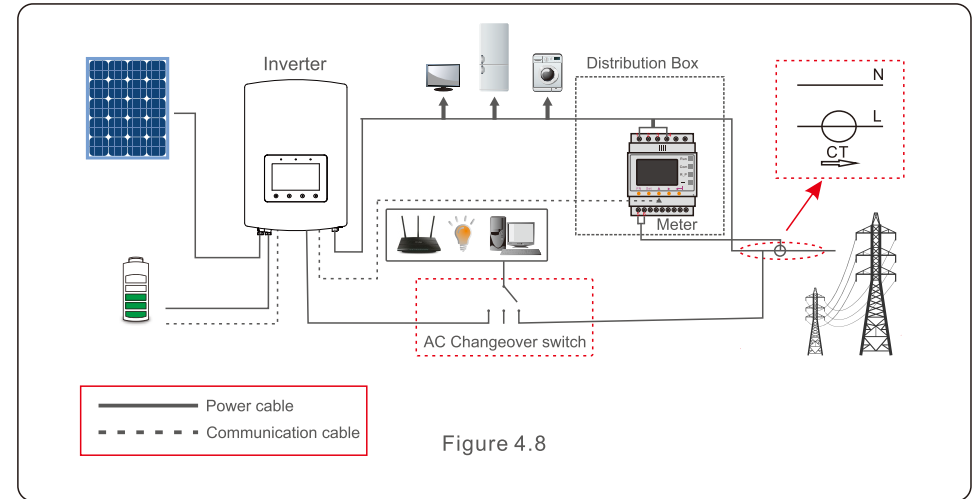

Figure 4.8

4.6.2 Three phase meter installation

Please follow below picture to install the 3-phase power meter and CT.

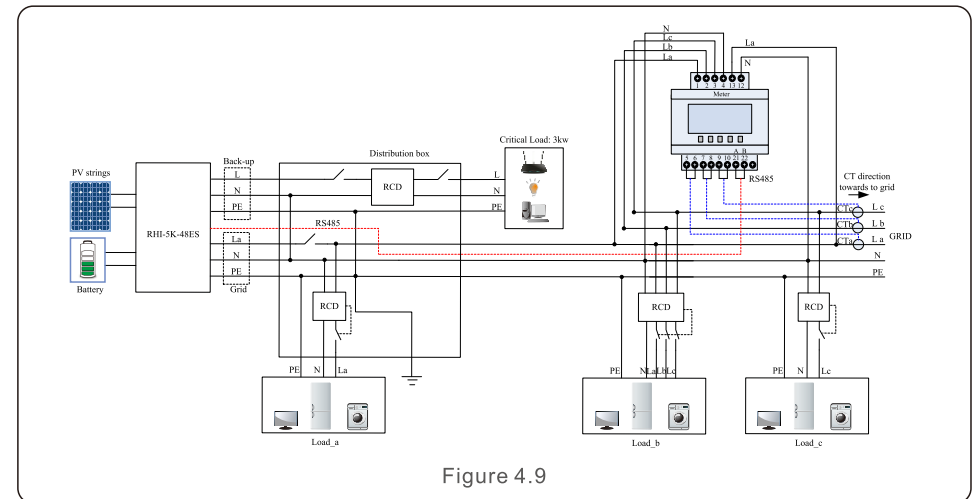

Figure 4.9

4. Installation

4. Installation

4.7 Communication Cable Assembly

The RHI series inverter uses RS485 cable to communicate with the Meter and CAN to communicate with the battery's BMS. The image below shows the assembly of the RS485/CAN communication cables.

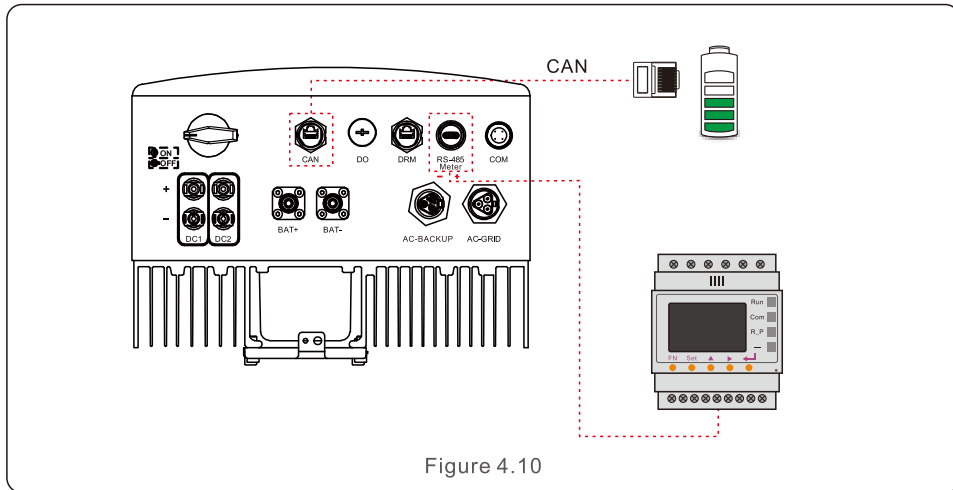

NOTE:

The CAN cable enables the communication between the inverter and the Li-ion battery from BYD, Pylon, etc. Please check for latest model compatibility before installation.

Procedure for connecting the CAN cable:

1. Take out the CAN cable (terminal marks 'CAN' on one end and 'to Battery' on the other end).
2. Unscrew the swivel nut from CAN port.
3. Insert the RJ45 terminal with CAN label into the CAN port, then fasten the swivel nut.
4. Connect the other end to the battery.



NOTE:

For CAN cable pin 4 (blue) and pin 5 (white-blue) are used for the communication.

Procedure for connecting the RS485 cable:

1. Take out the RS485 cable (terminal marks 'RS485' on one end and 'to Battery' on the other end).
2. Unscrew the swivel nut from RS485 port.
3. Insert the Two-pin terminal with RS485 label into the RS485 port, then fasten the swivel nut.
4. Connect the other end to the Meter.

4.8 Logic interface connection (Only for UK)

Logic interface is required by G98 and G99 standard that can be operated by a simple switch or contactor. When the switch is closed the inverter can operated normally. When the switch is opened, the inverter will reduce it's output power to zero within 5s.

Pin5 and Pin6 of RJ45 terminal is used for the logic interface connection.

Please follow steps below to assemble DRM RJ45 connector.

1. Insert the network cable into the communication connection terminal of RJ45. (As shown in figure 4.11)



Figure 4.11 RJ45 communication connection terminals

2. Use the network wire stripper to strip the insulation layer of the communication cable. According to the standard line sequence of figure 4.12 connect the wire to the plug of RJ45, and then use a network cable crimping tool to make it tight.

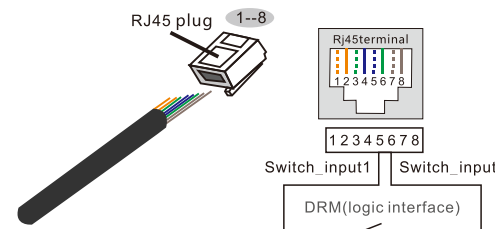

Correspondence between the cables and the stitches of plug, Pin5 and Pin6 of RJ45 terminal is used for the logic interface, other Pins are reserved.

- Pin 1: Reserved; Pin 2: Reserved
- Pin 3: Reserved; Pin 4: Reserved
- Pin 5: Switch_input1; Pin 6: Switch_input2
- Pin 7: Reserved; Pin 8: Reserved

Figure 4.12 Strip the insulation layer and connect to RJ45 plug

4. Installation

3.Connect RJ45 to DRM (logic interface) .



NOTE:
To use this function , please contact the manufacturer.

4.9 LED Indicates

There are three LED indicators on the RHI inverter (Red, Green, and Orange) which indicate the working status of the inverter.



POWER



OPERATION



ALARM

Light	Status	Description
● POWER	ON	The inverter can detect DC power.
	OFF	No DC power.
● OPERATION	ON	The inverter is fully operational.
	OFF	The inverter has stopped operating.
	FLASHING	The inverter is initializing.
● ALARM	ON	Fault condition is detected.
	OFF	No fault condition detected.
	FLASHING	Either the grid or solar cannot be detected.

Table 4.1 Status Indicator Lights

5. Operation

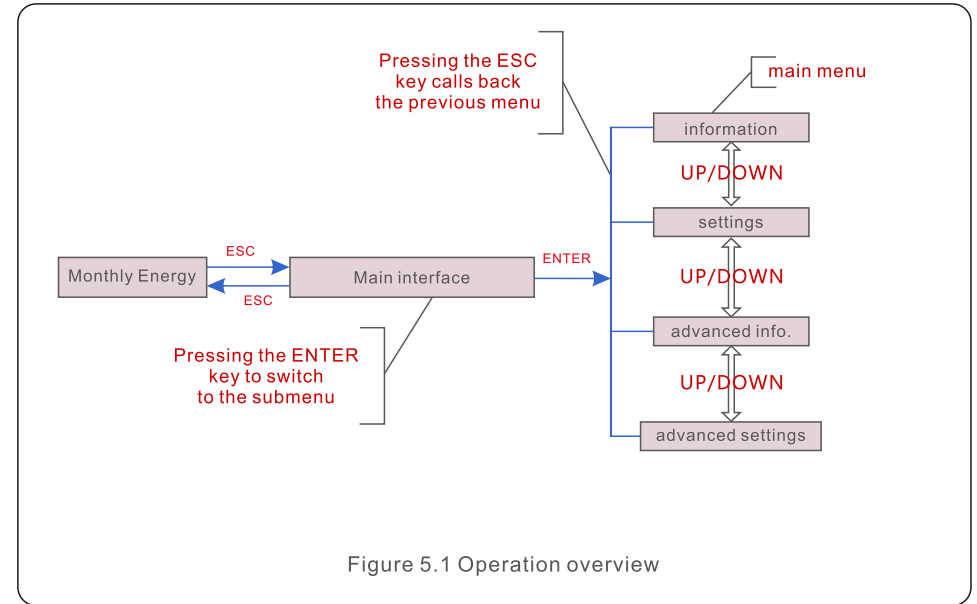

Figure 5.1 Operation overview

5. Operation

5. Operation

5.1 Interface

The initial interface of the inverters shown the language setting as below. Please set the relevant language.

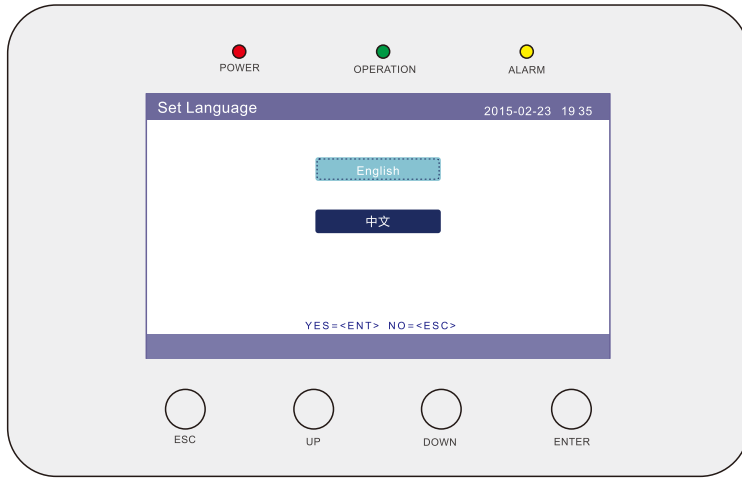

Figure 5.2 Set language

After setting language, then press ESC to see the main interface as below.

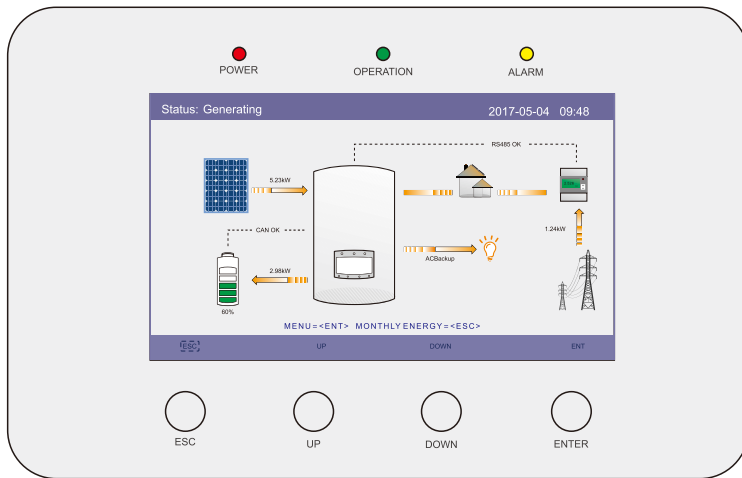







Figure 5.3 The main interface

	Solar – when solar power is being generated an arrow for the direction of power is displayed. Also the amount of power generated by the sun is displayed.
	Battery – when successfully connected to a supported battery management system the screen displays a “CAN OK” message. Also the arrow demonstrates the direction of power.
	Non-critical loads – this represents the loads that will be turned off when the grid is lost.
	Meter- when successfully connected to a supported battery meter the screen displays a “RS485 OK” message.
	Critical loads – this represents the loads that will remain on when the grid is lost. The arrow represents the direction of power.
	Grid – this represents the grid and the arrow represents the direction of power flow. If no grid is present the arrow will disappear.

5.1.1 Main Menu

There are four submenu in the Main Menu:

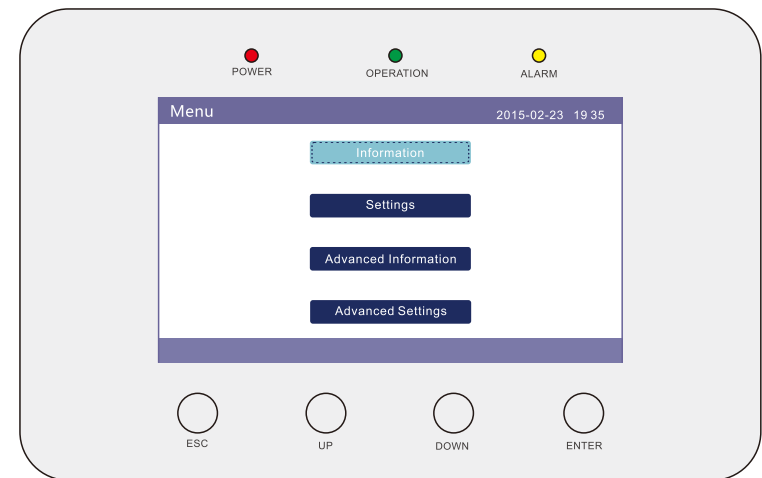

Figure 5.4 Main menu

5. Operation

5. Operation

5.2 Information

The inverter LCD provides access to operational data and information. Select "Information" in the sub menu. The user can access more data by scrolling up or down.

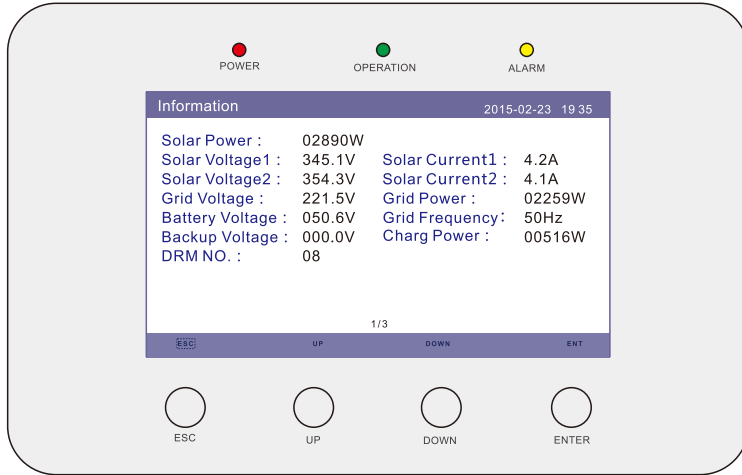

Figure 5.5 Information(1)

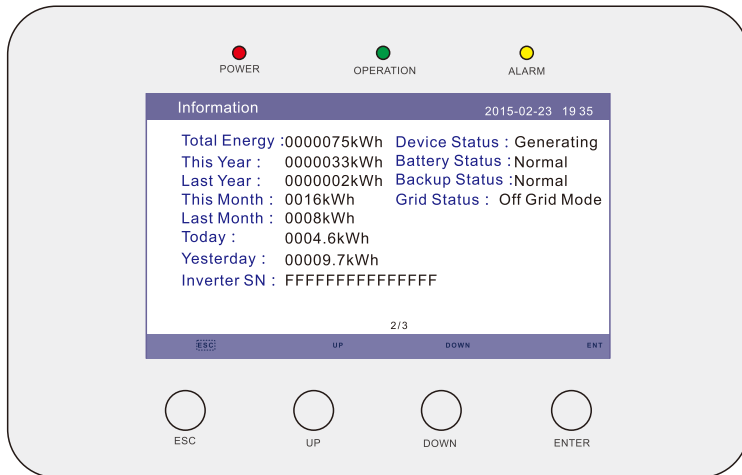

Figure 5.6 Information(2)

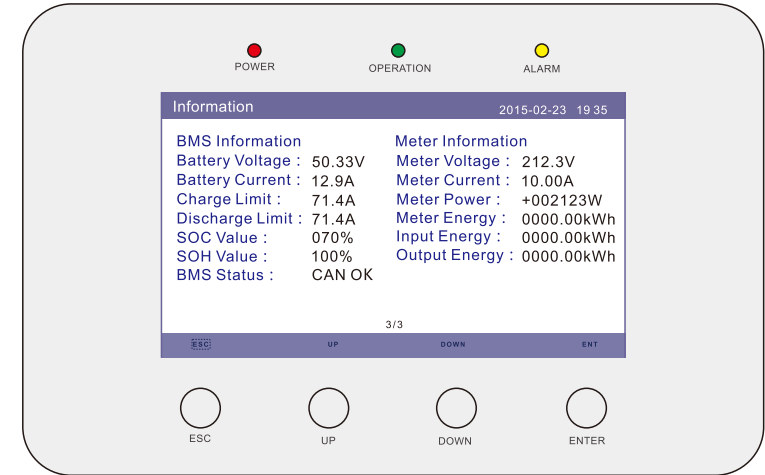

Figure 5.7 Information(3)

5.3 Settings

The following interface is displayed when the Settings menu is selected. Press the UP/DOWN keys to select different option, press the ENTER key to enter the submenu.

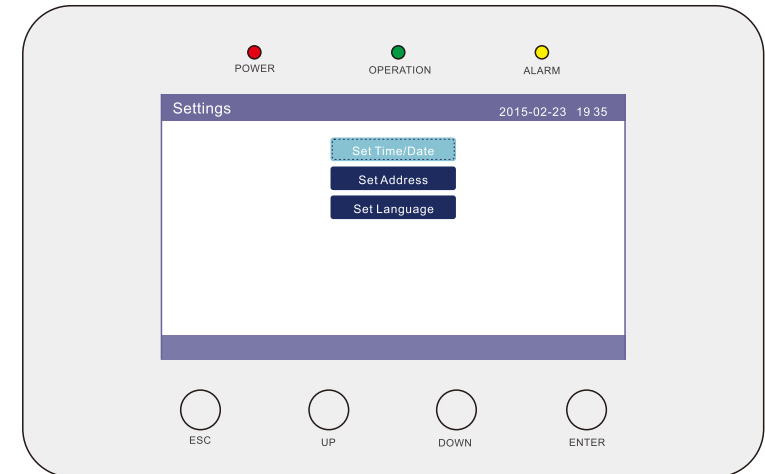

Figure 5.8 Setting

5. Operation

5.3.1 Set Time

This function allows the user to set the date and time. When this function is selected, the LCD will display a screen as shown in Figure 5.9.

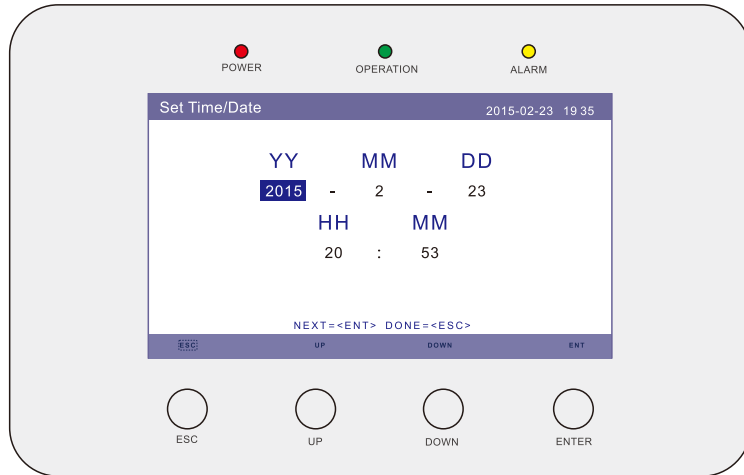

Figure 5.9 Set time

Press the UP/DOWN keys to set data and time. Press the ENTER key to move from one digit to the next (from left to right). Press the ESC key to save the settings and return to the previous menu.

5. Operation

5.3.2 Set Address

This function is used to set the address when multiple inverters are connected to single monitor. The address number can be assigned from "01" to "99"(see Figure 5.10). The default address number of Solis Hybrid Inverter is "01".



Figure 5.10 Set address

Press the UP/DOWN keys to set the address. Press the ENTER key to save the settings. Press the ESC key to cancel the change and return to the previous menu.

5.3.3 Set Language

This function is used to set the language of inverter LCD display.

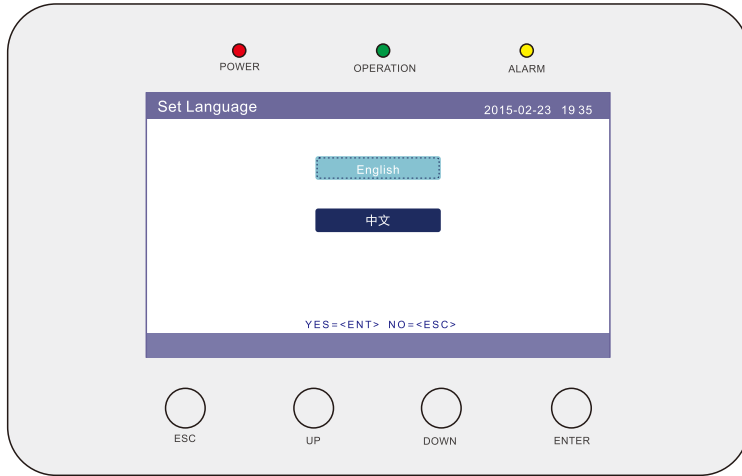

Figure 5.11 Set language

5.4 Advanced Info



NOTE:

Password required – restricted access – authorised technicians.
Un-authorized access may void the warranty.

Select Advanced Info from main menu, Select Advanced Info from main menu, the LCD will show as below:

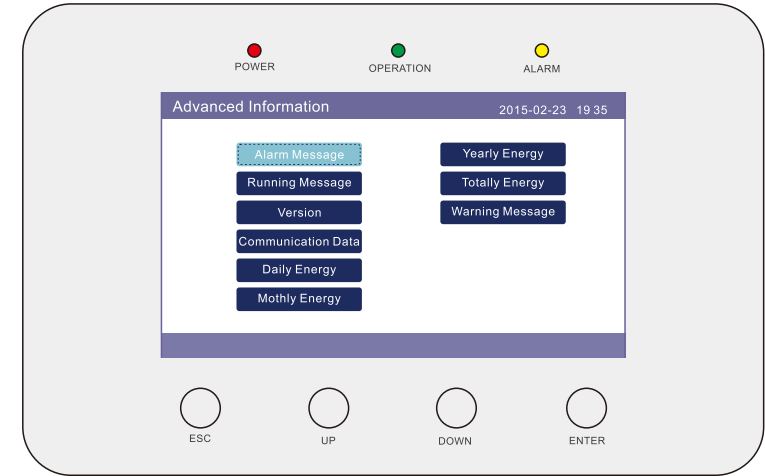

Figure 5.12 Advanced information

The screen can be scrolled manually by pressing the UP/DOWN keys.

Pressing the ENTER key gives access to a submenu.

5.4.1 Alarm Message

The display shows the 10 pages of latest alarm messages (see Figure 5.13), and every page has 5 alarm messages. (Alarm message shows that inverter meets the problem that has to adopt shutdown protection. Screens can be scrolled manually by pressing the UP/ DOWN keys.

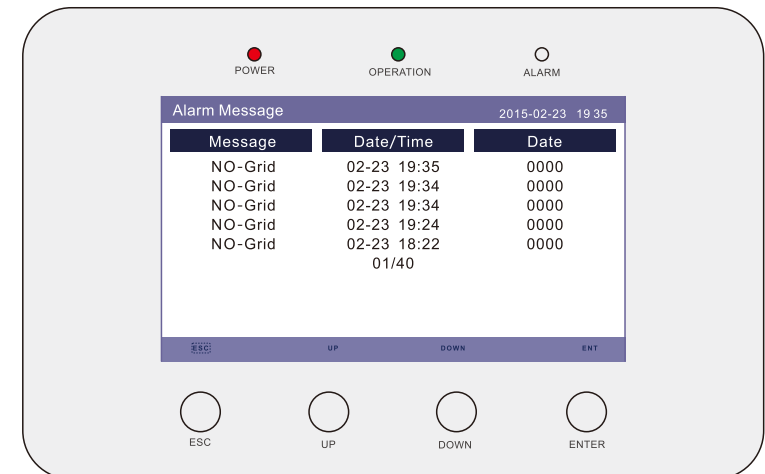

Figure 5.13 Alarm message

5. Operation

5.4.2 Running Message

This function is for maintenance person to get running message such as internal temperature, Standard NO. etc.(see Figure 5.14).

Screens can be scrolled by pressing the UP/DOWN keys.

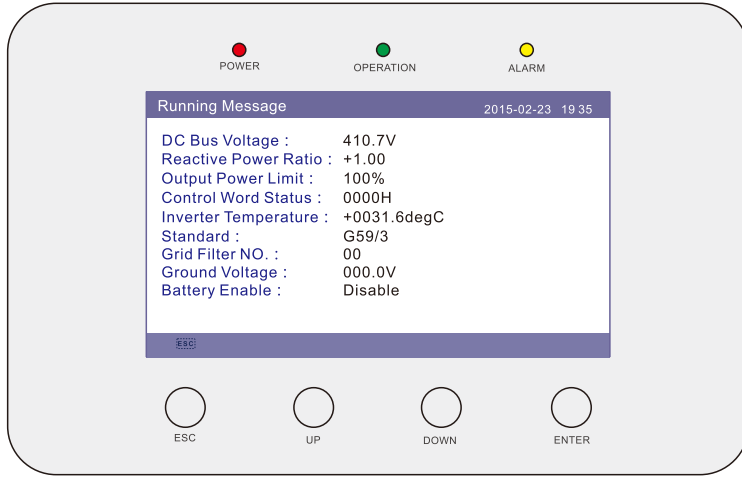

Figure 5.14 Running message

5.4.3 Version

The screen shows the model version and the software version of the Inverter (see Figure 5.15).

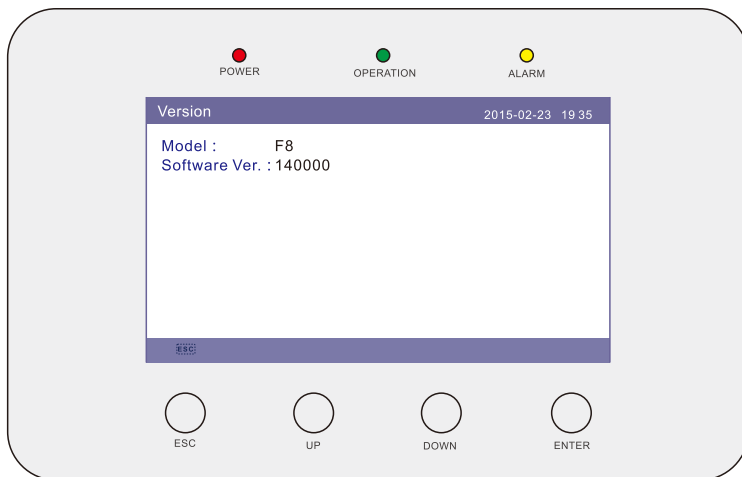

Figure 5.15 Model Version and Software Version

5. Operation

5.4.4 Communication Data

The screen shows the internal data of the inverter (see Figure 5.16), which is for service technicians only.

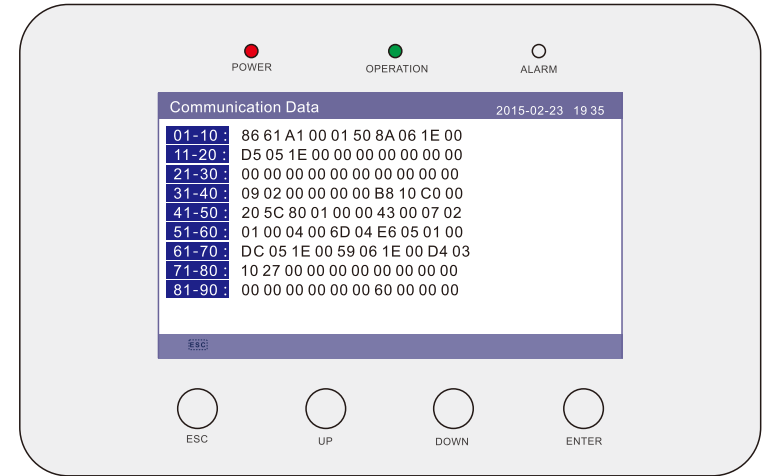

Figure 5.16 Communication data

5.4.5 Daily Energy

The screen shows the daily energy detail of the inverter (see Figure 5.17).

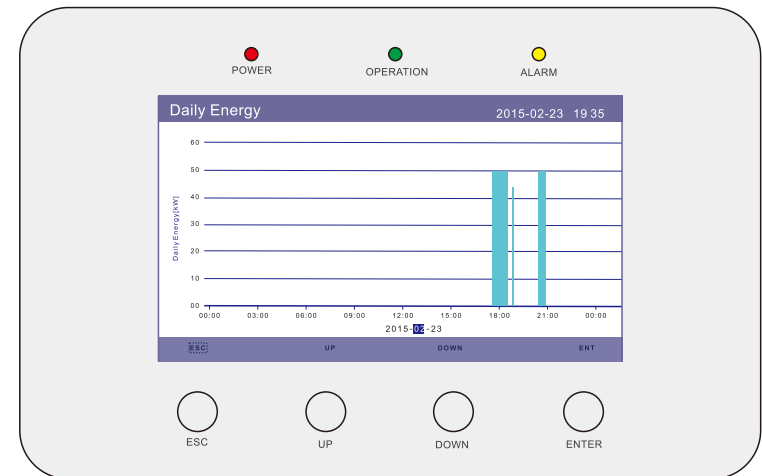

Figure 5.17 Select date for daily energy

Press the Enter key to move cursor.

Press the UP/DOWN keys to view hourly output power.

5. Operation

5. Operation

5.4.6 Monthly Energy

The screen shows the inverter monthly energy detail of different month (see Figure 5.18).

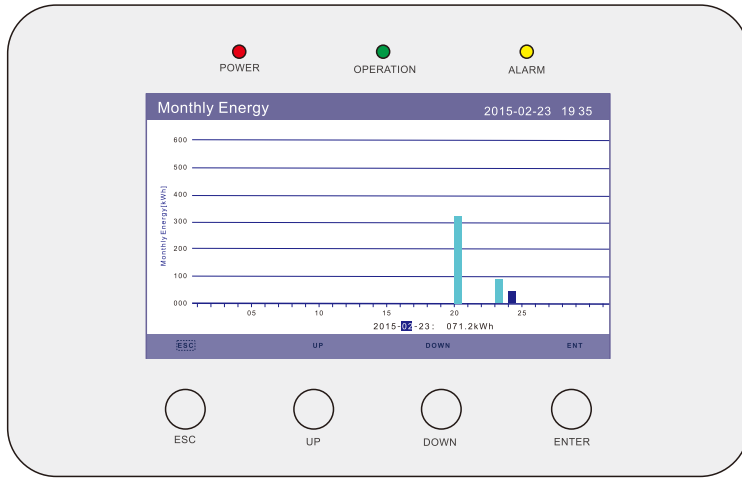

Figure 5.18 Monthly power generation details

Press the Enter key to move cursor.

Press the UP/DOWN keys to view daily output power.

5.4.7 Yearly Energy

The screen shows the inverter yearly energy detail of different year (see Figure 5.19).

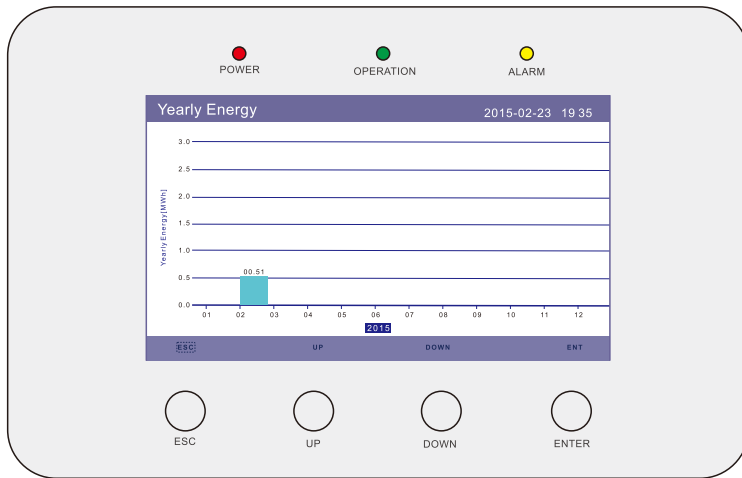

Figure 5.19 Annual generating capacity details

Press the Enter key to move cursor.

Press the UP/DOWN keys to view monthly output power.

5.4.8 Total Energy

The screen shows the inverter total energy detail (see Figure 5.20).

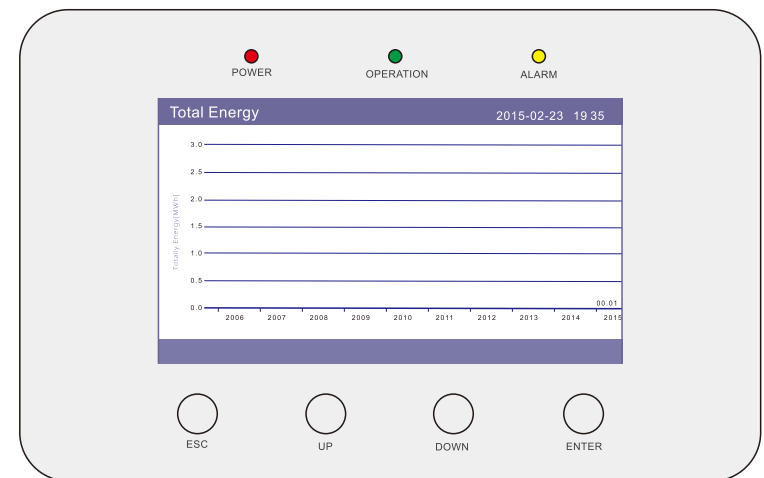

Figure 5.20 Total generating capacity details

5.4.9 Warning Message

The display shows the 10 pages of latest warning messages (see Figure 5.21), and every pages has 5 warning messages. (Warning message means that the possible future danger is predicted.)

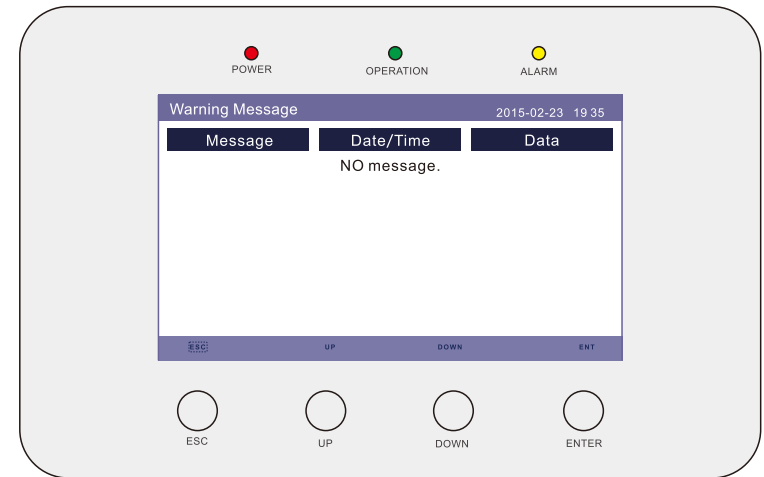

Figure 5.21 Warning message

5.5 Advanced Settings - Technicians Only



NOTE:

This function is for authorised technicians only. Improper access and operation may result in abnormal results and damage to the inverter.
 Password required – restricted access – authorised technicians only
 Un-authorized access may void the warranty.

Select Advanced Settings from main menu, the LCD screen show the password is needed:

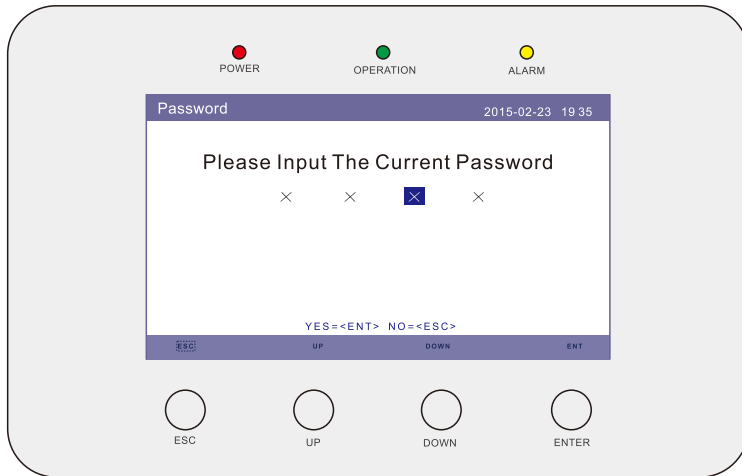

Figure 5.22 Enter a password

The default password is "0010", press the UP/DOWN keys to move cursor, press the ENTER key to select the digit you want to change. Use the UP/DOWN buttons to change the figure for input password. After entering correct password, the LCD will show as below:

Select Advanced Settings from the Main Menu to access the following options:

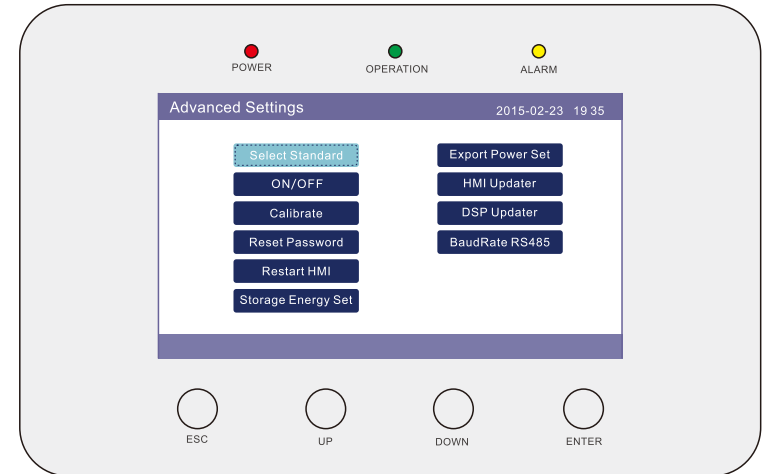

Figure 5.23 Advanced settings

5.5.1 Select Standard

This function is used to select corresponding grid standards. (see Figure 5.24). Please refer to the actual LCD setting for the grid standard options.

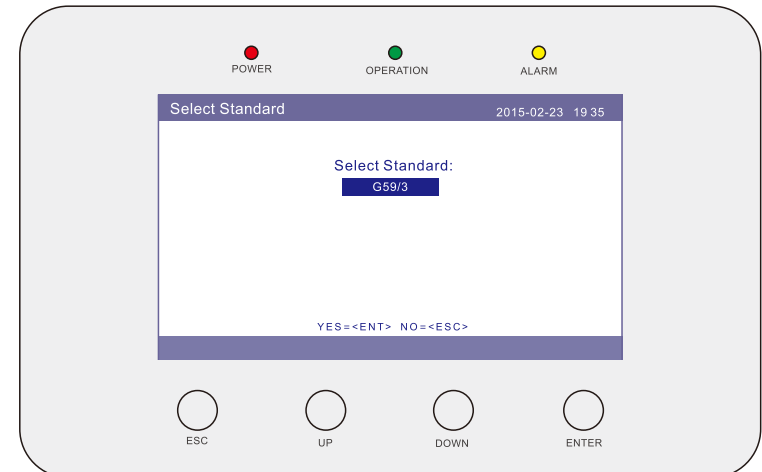

Figure 5.24 Select Standard

5. Operation

5.5.2 ON/OFF

This function is used to start or stop the generation of the inverter (see Figure 5.25).

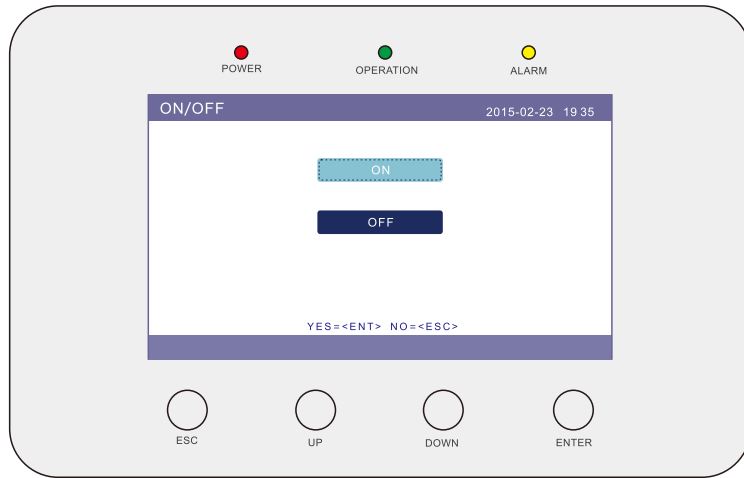

Figure 5.25 Set ON/OFF

Press the UP/DOWN key to move the cursor.
Press the ENTER key to execute the setting.
Press the ESC key to return to the previous menu.

5. Operation

5.5.3 Calibrate

Warranty or maintenance may result in resetting total generating data, this function allow the maintenance personnel to amend the total generating data of replacement inverter to the original one.

By using our data monitoring hardware, the data on monitoring website can automatically synchronize with the preset total generating power of inverter.

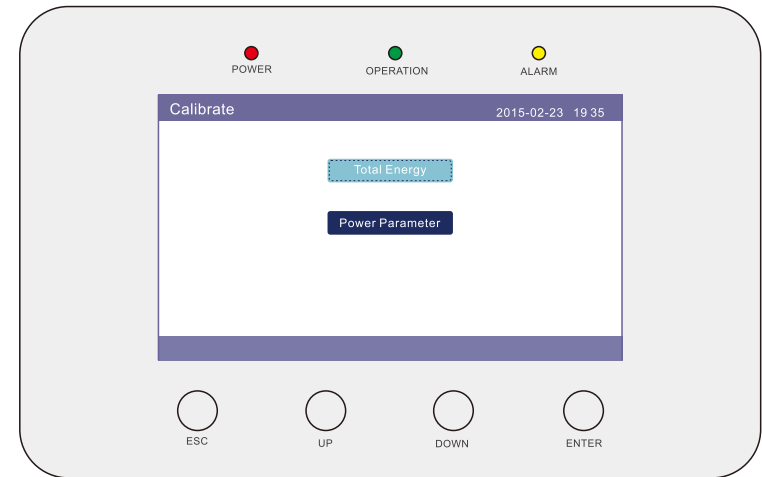

Figure 5.26 Calibrate

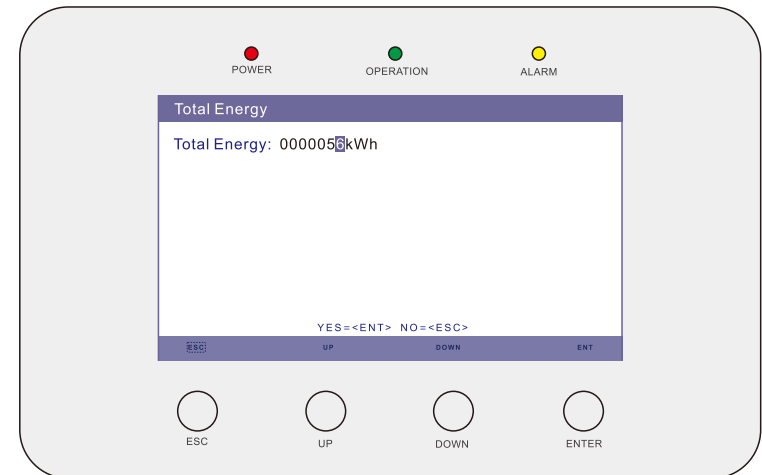

Figure 5.27 Total Energy

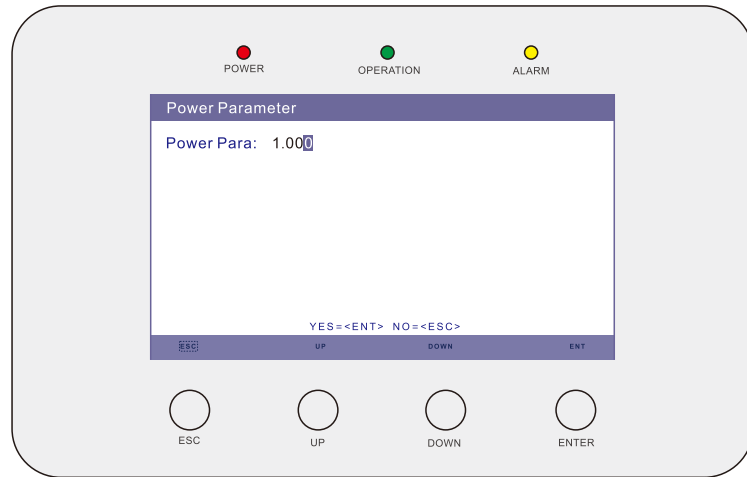

Figure 5.28 Power Parameter

Press the DOWN key to move the cursor, Press the UP key to revise the value.
 Press the ENTER key to execute the setting.
 Press the ESC key to return to the previous menu.

5.5.4 Reset Password

Reset Password: In this page, user can reset the inverter password, but the original password remains.

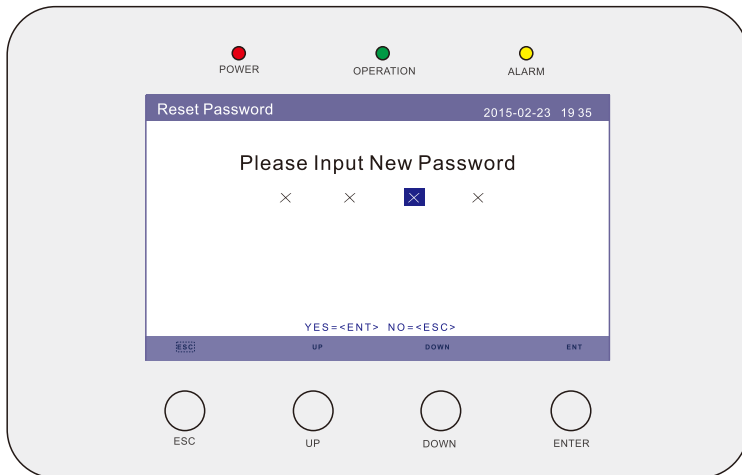

Figure 5.29 Reset password

5.5.5 Restart HMI

This function is to reboot the LCD screen.

5.5.6 Storage Energy Set

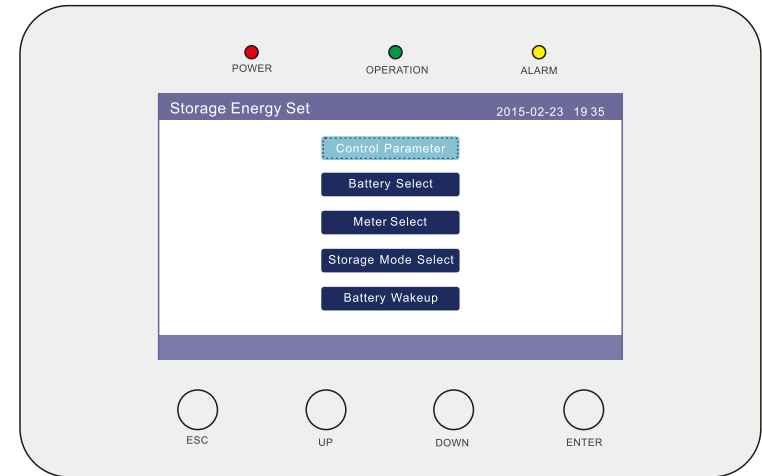

Figure 5.30 Storage Energy set

5.5.6.1 Control Parameter

Enter the Control Parameter menu as shown below:

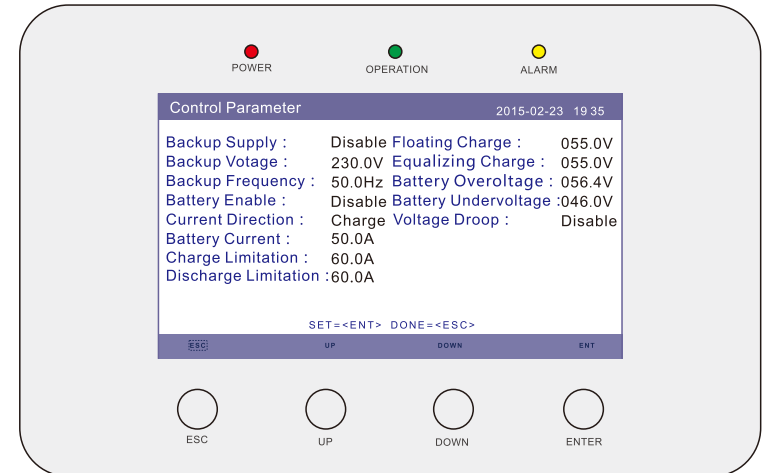

Figure 5.31 Control Parameter

5.5.6.2 Battery Select

There are some options about battery modules. If you select default battery modules, such as B-BOX-LV, Pylon US2000B. When some battery module is selected, pre-settings will be imported, user doesn't need to configure the battery parameters except for over discharge SOC and forced charge SOC. If the battery is not connected for the moment, choose the "No Battery" option to avoid corresponding alarms.

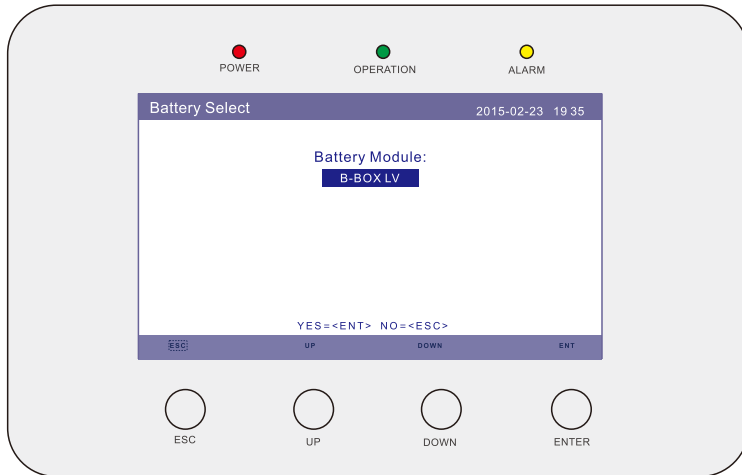

Figure 5.32 B-BOX-LV (optional)

The OverDischg SOC can be set from 10% to 40%.

The ForceChagre SOC can be set from 5% to OverDischg SOC.

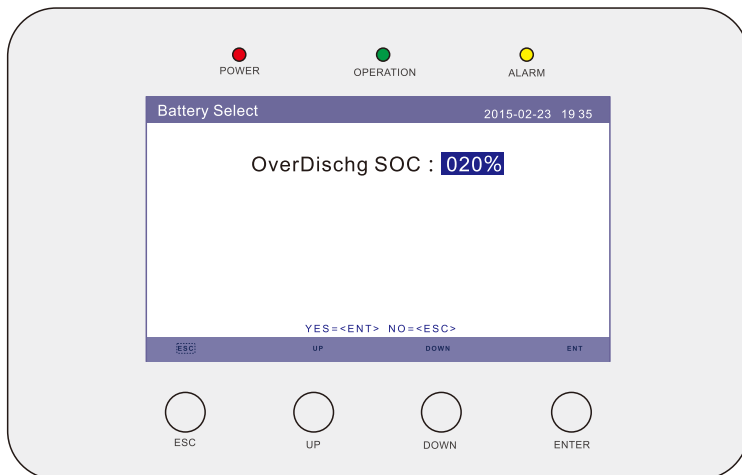

Figure 5.33 Over discharge SOC.

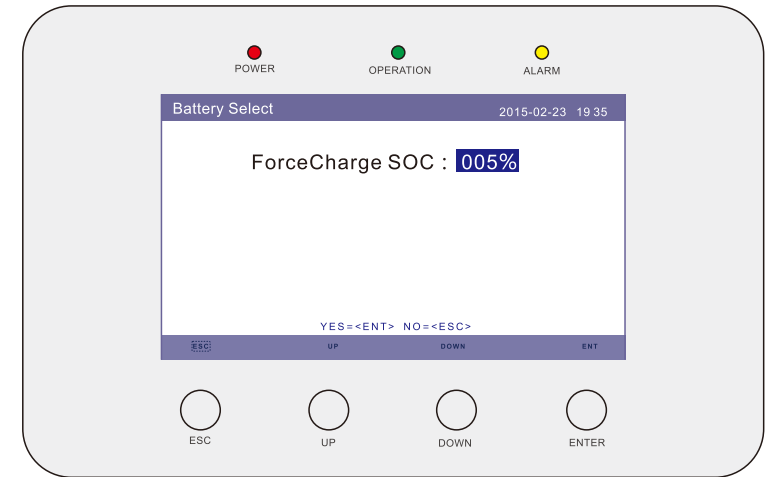

Figure 5.34 ForceCharge SOC

Forced charge SOC is used to maintain the minimum SOC of the battery and prevent it going into sleep mode. Inverter will charge the battery if the SOC is below the value.

If your battery is not included, please choose "User-Define" to configure the battery parameters. Then press ENTER to modify the defaults.

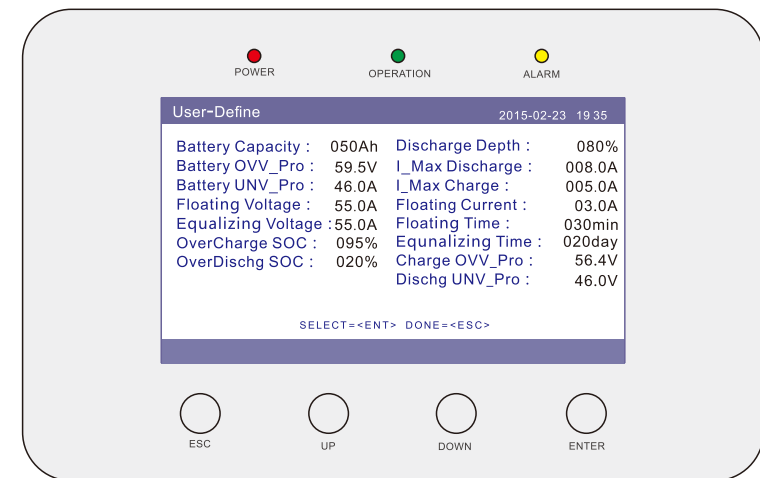

Figure 5.35 User-Define

1. Battery Capacity: 050Ah, set the capacity of the battery bank;
2. Battery OVV_Pro: 59.5V, set the maximum voltage of battery can be charged to;
3. Battery UNV_Pro: 46.0V, set the minimum voltage of battery can be charged to;
4. Floating Voltage: 55.0V, set the voltage at floating charge mode;
5. Equalizing Voltage: 55.0V, set the voltage at equalizing charge mode;
6. Overcharge SOC: 095%, set the maximum SOC of battery can be charged to;
7. Overdischarge SOC: 020%, set the minimum SOC of battery can be discharged to;
8. Discharge Dept: 081%, set percentage of battery energy that can be discharged;
9. I_Max_Discharge: 005.0A, set the maximum discharge current of battery;
10. I_Max_Charge: 005.5A, set the maximum charge current of battery;
11. Floating Current: 03.0A, set the charge current, at which the charge mode forces a change into floating charge;
12. Floating Time: 030min, set the charging time before moving into floating charge mode, once reached charge voltage;
13. Equalizing Time: 000day, set the time period for inverter to charge the battery once to full;
14. Charge OVV_Pro: 56.4V, set maximum voltage of battery can be charged to;
15. Discharge UNV_Pro: 46.0V, set the minimum vltage of battery can be discharged to.

5.5.6.3 Meter Select

This setting is used to select the meter type based on the actual configuration. Both single phase meter and three phase meter can be equipped with this hybrid inverter. Detailed configuration please refer to 4.6.1 and 4.6.2.

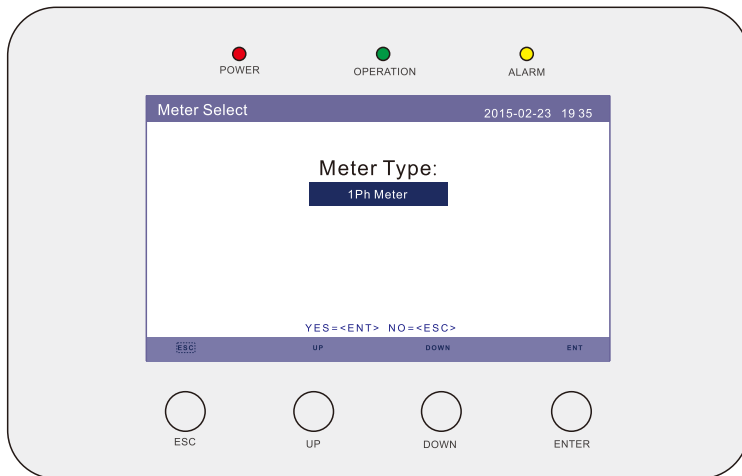

Figure 5.36 Storage Energy Set

5.5.6.4 Storage Mode Select

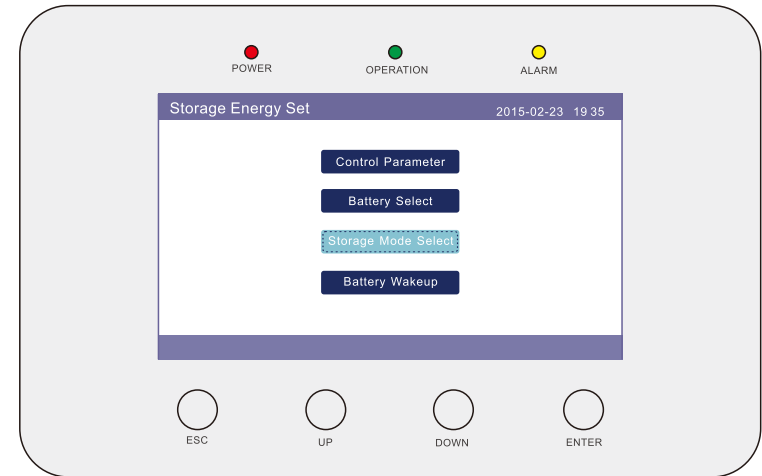

Figure 5.37 Storage Energy Set

There are three options in the Storage Mode Select: Time charging, Off-grid and Reserve Battery modes. Another default mode is Auto mode (Maximize the self-consumption rate) which is not shown in the setting. Once the inverter is started, it is working in the Auto mode. If want to switch back to Auto mode, simply turn off the other modes, then it is automatically operating in the Auto mode, even though it is NOT shown on the screen.

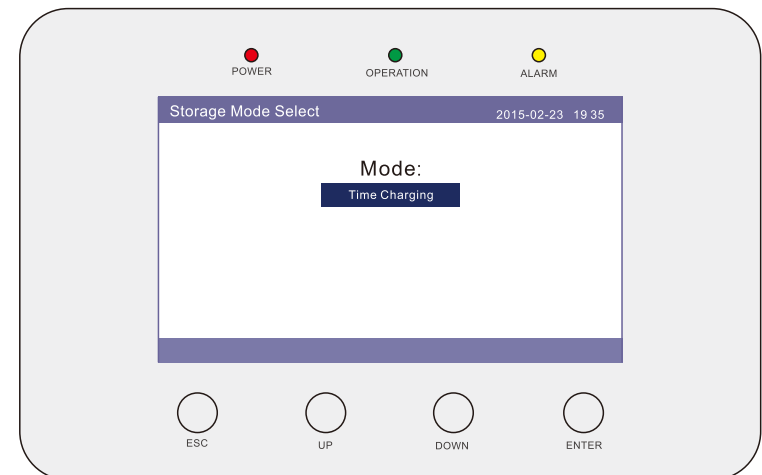

Figure 5.38 Storage Mode Select

The user can set the time periods, for when the inverter charges and discharges the batteries, using Time Charging Mode.

In installations where no grid is present, it is recommended to use Off-Grid mode

In some cases, if the battery is used as the emergency backup source, it is recommended to use battery Reserve Battery mode. It will keep the battery at a certain SOC for emergency cases.

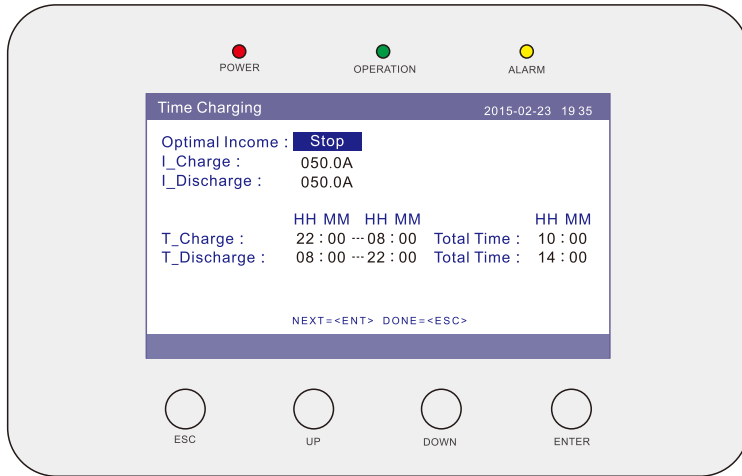

Figure 5.39 Time Charging

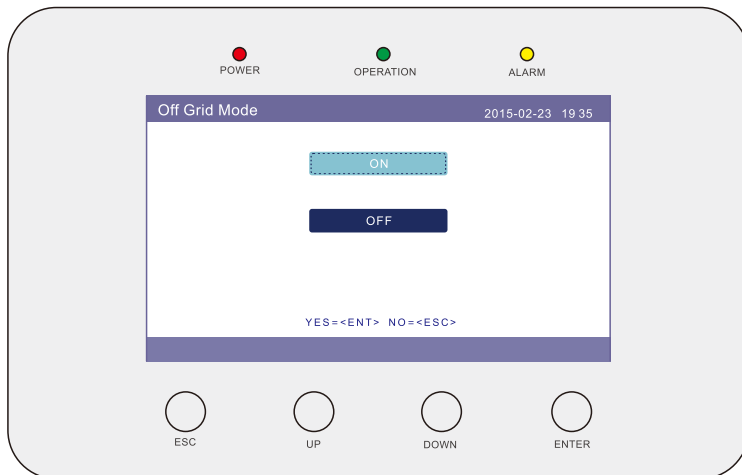

Figure 5.40 Off-grid Mode

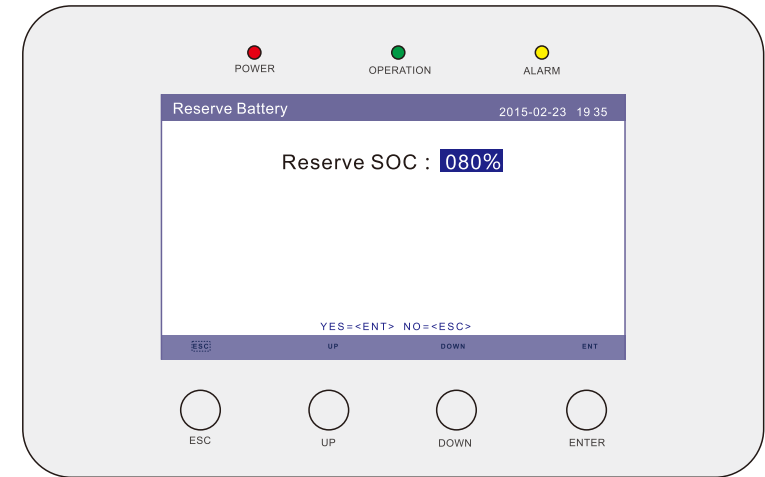

Figure 5.41 Reserve battery

5.5.6.4 Battery Wakeup

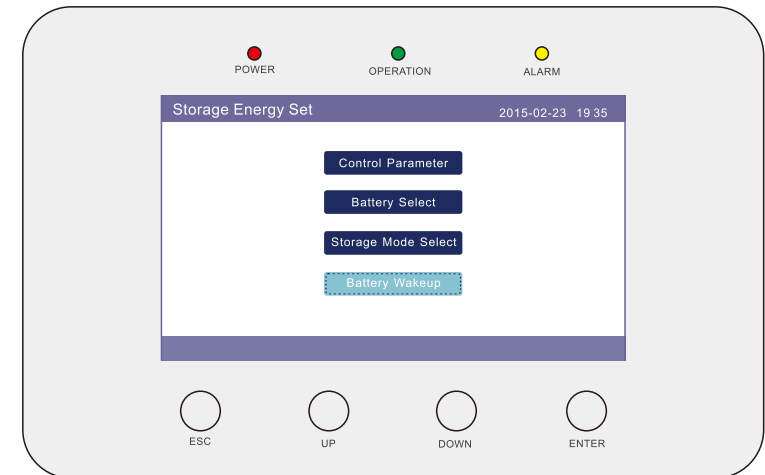

Figure 5.42 Battery Wakeup

This function should be activated only after the installation. In the case of a low battery voltage shutdown, the inverter will shut-down. This setting can be enabled, so when the inverter detects PV or grid it wakes up the battery. This function conflicts with the battery reverse polarity protection(If the installer connects cables with wrong polarity, the inverter can protect itself from damage).To avoid the possible damage during installation, do not active battery wakeup function before finishing the first commissioning.

5.5.7 Export power Set

This function is to set export power.

There are 3 items in the sub-menu: Backflow Power, ON/OFF, FailSafe ON/OFF.

As shown as below.

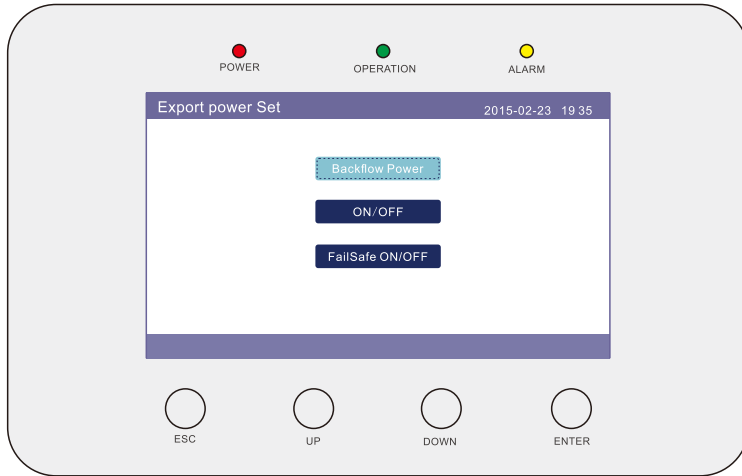

Figure 5.43 Export power Set

“ON/OFF” item is prior to 2 items. Only “ON/OFF” state is “ON”, other 2 items can work it.

5.5.7.1 Backflow Power

This sub-menu is used for setting allowed power that inverter can export to grid.

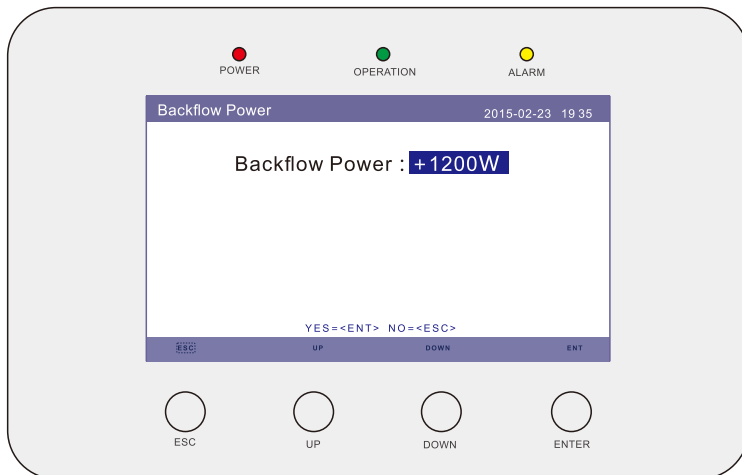

Figure 5.44 Backflow Power

5.5.7.2 ON/OFF

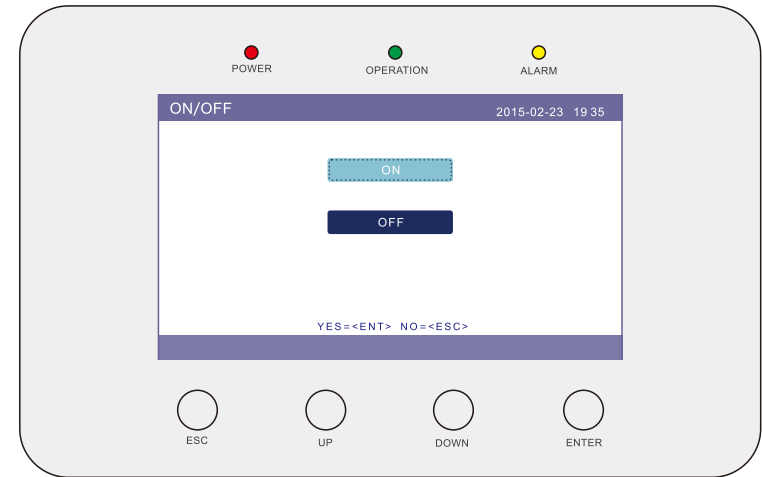

Figure 5.45 ON/OFF

Press the UP/DOWN keys to set ON/OFF. Press the ENTER key to set done .

Press the ESC key to the previous menu.

5.5.7.3 FailSafe ON/OFF

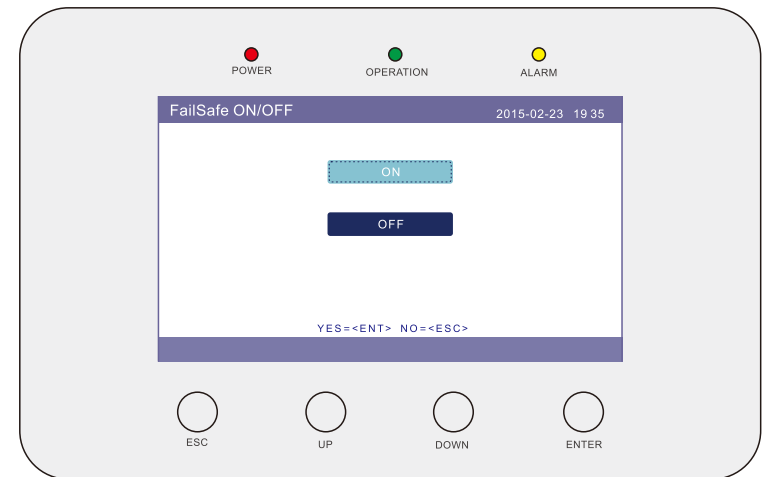

Figure 5.46 FailSafe ON/OFF

Press the UP/DOWN keys to set ON/OFF. Press the ENTER key to set done .

Press the ESC key to the previous menu.

5. Operation

5. Operation

5.5.8 HMI Updater

This function is used to update HMI software.

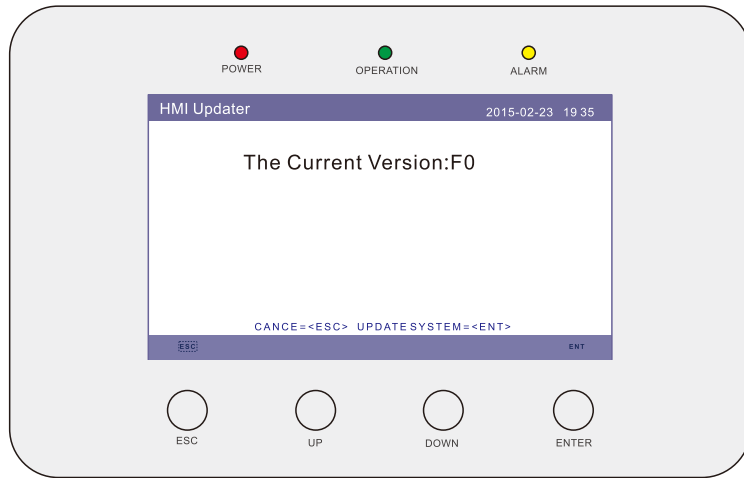

Figure 5.47 HMI updater

5.5.9 DSP Updater

This function is used to update DSP software.

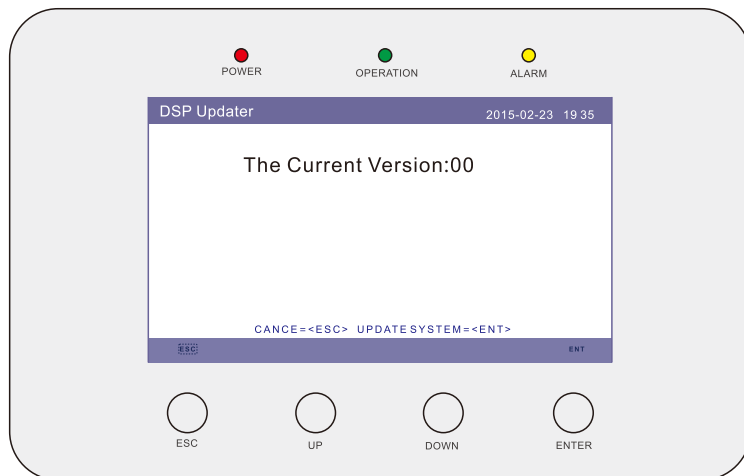

Figure 5.48 DSP updater



WARNING:

This function is for maintenance personnel only, wrong operation will prevent the inverter from working properly.

5.5.10 BaudRate RS485

This sub-menu is used for setting allow users select the Baudrate.

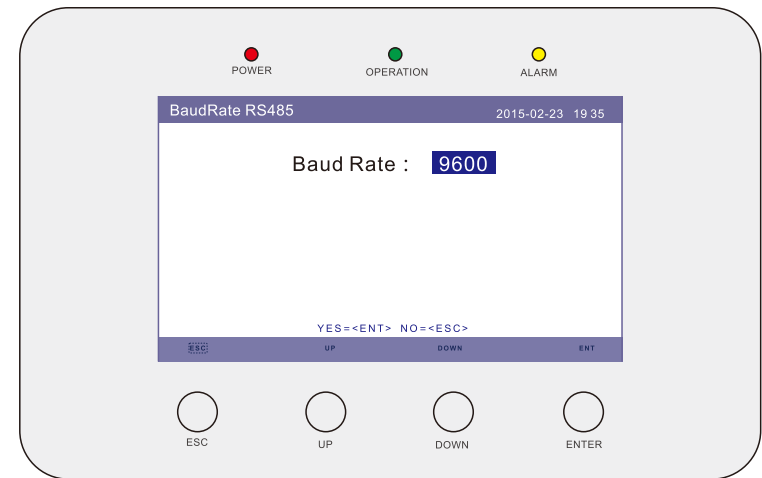

Figure 5.49 BaudRate RS485

6. Commissioning

6.1 Preparation of Commissioning

- Ensure all the devices are accessible for operation, maintenance and service.
- Check and confirm that the inverter is firmly installed.
- Space for ventilation is sufficient for one inverter or multiple inverters.
- Nothing is left on the top of the inverter or battery module.
- Inverter and accessories are correctly connected.
- Cables are routed in safe place or protected against mechanical damage.
- Warning signs and labels are suitably affixed and durable.

6.2 Commissioning Procedure

If all the items mentioned above meet the requirements, proceed as follows to start up the inverter for the first time.

6.2.1 Switch on the AC-backup and AC-grid.

6.2.2 Follow the picture below to select grid standard.

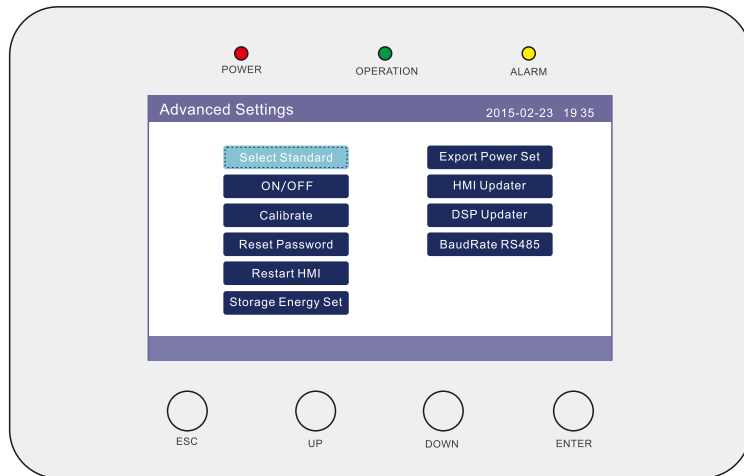

6.2.3 Refer to “Part 5” to configure the parameters.

6.2.4 Switch on the DC circuit breaker between inverter and battery.

6.2.5 (Optional) When the battery equipped is Pylon Li-ion Battery, or BYD battery, turn on the switch on the battery manually.

6.2.6 The relay will make 'clicking' sounds and it will take a short-time to work automatically.

6.2.7 The system will work properly.

7. Troubleshooting

Solis RHI Series inverter does not require any regular maintenance. However, cleaning the heatsink will help inverter dissipating heat and increase the lifetime of inverter. The dirt on the inverter can be cleaned with a soft brush.



CAUTION:

Do not touch the surface when the inverter is operating. Some parts may be hot and cause burns. Turn OFF the inverter (refer to Section 6.2) and let it cool down before you do any maintenance or cleaning of inverter.

The LCD and the LED status indicator lights can be cleaned with cloth if they are too dirty to be read.



Note:

Never use any solvents, abrasives or corrosive materials to clean the inverter.

The inverter has been designed in accordance with international grid tied standards for safety, and electromagnetic compatibility requirements. Before delivering to the customer the inverter has been subjected to several test to ensure its optimal operation and reliability.

In case of a failure the LCD screen will display an alarm message. In this case the inverter may stop feeding energy into the grid. The alarm descriptions and their corresponding alarm messages are listed in Table 7.1:

7. Troubleshooting

When faults occur, the "Fault" state will be shown on the main screen. Follow the steps below to check what fault occurs.

Steps: Enter → Down → Advanced Information → Enter → Alarm Message.

Step1: Press ENTER.

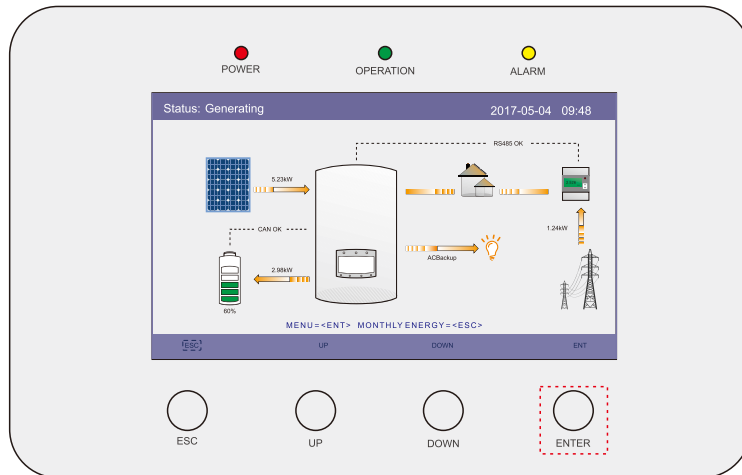

Step2: Press DOWN to select Advanced Information, then press ENTER.

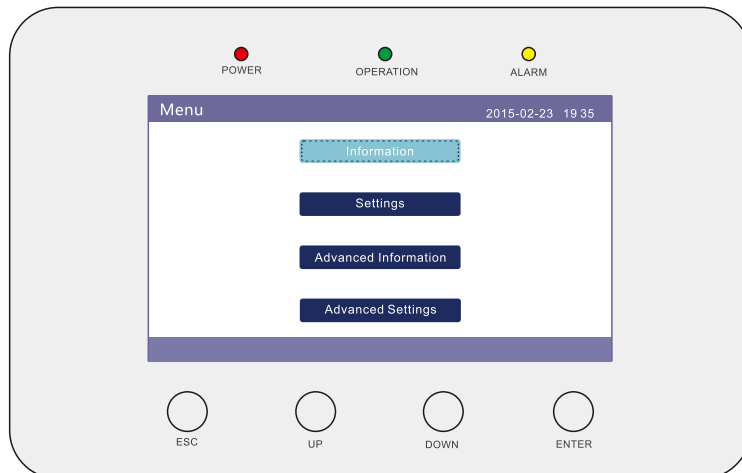

7. Troubleshooting

Step3: Press DOWN to select Alarm Message, then press ENTER.

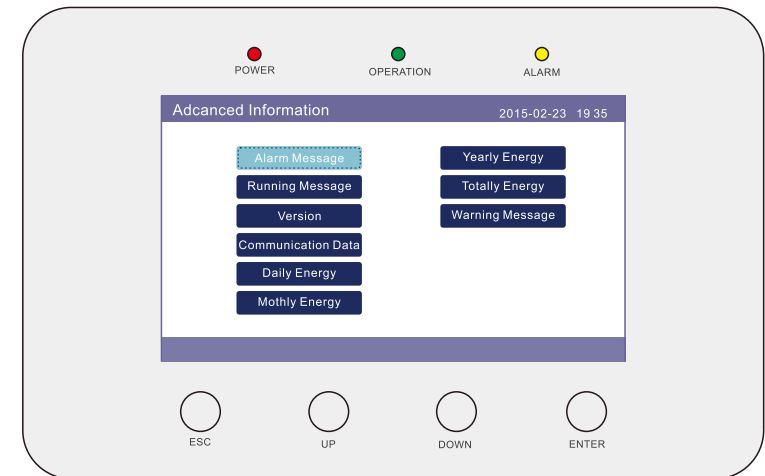

7. Troubleshooting

Alarm Message	Failure description	Solution
ARC-FAULT	ARC detected in DC circuit	1. Check if there's arc in PV connection and restart inverter.
AFCI Check FAULT	AFCI module self check fault	1. Restart inverter or contact installer.
DCinj-FAULT	High DC injection current	1. Restart inverter or contact installer.
DSP-B-FAULT	Comm. failure between main and slave DSP	1. Restart inverter or contact installer.
DC-INTF	DC input overcurrent	1. Restart inverter. 2. Identify and remove the string to the fault MPPT. 3. Change power board.
G-IMP	High grid impedance	1. Use user define function to adjust the protection limit if it's allowed by electrical company.
GRID-INTF01/02	Grid interference	1. Restart inverter. 2. Change power board.
IGBT-OV-I	Over IGBT current	
IGFOL-F	Grid current tracking fail	1. Restart inverter or contact installer.
IG-AD	Grid current sampling fail	
lLeak-PRO 01/02/03/04	leakage current protection	1. Check AC and DC connection. 2. Check inverter inside cable connection.
INI-FAULT	Initialization system fault	1. Restart inverter or contact installer.
LCD show initializing all the time	Can not start-up	1. Check if the connector on main board or power board are fixed. 2. Check if the DSP connector to power board are fixed.
NO-Battery	Unconnected battery	1. Check the wire of battery power is connected correctly or not. 2. Check the output voltage of battery is correctly or not.
No power	Inverter no power on LCD	1. Check PV input connections. 2. Check DC input voltage (single phase >120V, three phase >350V). 3. Check if PV+/- is reversed.
NO-GRID	No grid voltage	1. Check connections and grid switch. 2. Check the grid voltage inside inverter terminal.
OV-BUS	Over DC bus voltage	1. Check inverter inductor connection. 2. Check driver connection.

7. Troubleshooting

Alarm Message	Failure description	Solution
OV-DC01/02/03/04	Over DC voltage	1. Reduce the module number in series.
OV-DCA-I	DC input overcurrent	1. Restart inverter. 2. Identify and remove the string to the fault MPPT. 3. Change power board.
OV-G-V01/02/03/04	Over grid voltage	1. Resistant of AC cable is too high. Change bigger size grid cable. 2. Adjust the protection limit if it's allowed by electrical company.
OV-G-I	Over grid current	1. Restart inverter. 2. Change power board.
OV-G-F01/02	Over grid frequency	1. Use user define function to adjust the protection limit if it's allowed by electrical company.
OV-IgTr	AC side transient overcurrent	1. Restart inverter. 2. Return-factory repair.
OV-ILLC	LLC hardware overcurrent	
OV-VBackup	Bypass overvoltage fault	
OV-TEM	Over Temperature	1. Check inverter surrounding ventilation. 2. Check if there's sunshine direct on inverter in hot weather.
OV-Vbatt1	The detection of battery overvoltage	1. Check the protect point for over voltage sets correctly or not. 2. Restart inverter.
OV-Vbatt-H	Battery overvoltage hardware fault	1. Check the circle whether the circuit for battery power jumps. 2. Restart inverter.
Over-Load	Bypass overload fault	1. Check the load of Backup port is over 3kw or not. 2. Reduce the load of Backup port, then restart inverter.
PV ISO-PRO01/02	PV isolation protection	1. Remove all DC input, reconnect and restart inverter one by one. 2. Identify which string cause the fault and check the isolation of the string.
RelayChk-FAIL	Relay check fail	1. Restart inverter or contact installer.

7. Troubleshooting

Alarm Message	Failure description	Solution
UN-BUS01/02	Under DC bus voltage	1. Check inverter inductor connection. 2. Check driver connection.
UN-G-F01/02	Under grid frequency	1. Use user define function to adjust the protection limit if it's allowed by electrical company.
UN-G-V01/02	Under grid voltage	
12Power-FAULT	12V power supply fault	1. Restart inverter or contact installer.

Table 7.1 Fault message and description



NOTE:

If the inverter displays any alarm message as listed in Table 7.1; please turn off the inverter and wait for 5 minutes before restarting it. If the failure persists, please contact your local distributor or the service center.

Please keep ready with you the following information before contacting us.

1. Serial number of Solis Single Phase Inverter;
2. The distributor/dealer of Solis Single Phase Inverter (if available);
3. Installation date.
4. The description of problem (i.e. the alarm message displayed on the LCD and the status of the LED status indicator lights. Other readings obtained from the Information submenu (refer to Section 6.2) will also be helpful.);
5. The PV array configuration (e.g. number of panels, capacity of panels, number of strings, etc.);
6. Your contact details.

8. Specifications

Technical Data	RHI-3K-48ES	RHI-3.6K-48ES
Input DC (PV side)		
Max. DC input power	4kw	5kw
Max power per MPPT	4kW	
The max DC input voltage	600Vdc	
Nominal DC voltage	330Vdc	
Start-up DC voltage	120Vdc	
MPPT operating voltage range	90-520V	
Full load MPPT voltage range	141-520V	169-520V
MPPT number/Max input strings number	2/2	
The rating max DC input current(A/B)	11A/11A	
Max short circuit current for each MPPT	17.2A/17.2A	
Max.inverter backfeed current to the array	0A	
Battery		
Battery Type	Li-ion	
Battery Voltage range	42 - 58Vdc	
Battery Capacity	50 - 2000Ah	
Maximum Charging Power	3000W	
Maximum Charge/discharge current	62.5A/62.5A	
Output AC(Back-up)		
Rating output power	3kW	
Transient max. apparent output power	4kVA, 10sec	
Back-up switch time	<10ms	
Operation phase	L-N-PE	
Rated grid voltage	220/230/240Vac	
Rated frequency	50/60Hz	
Rated output current	13A	
THDi	2%(linear load)	
Input AC (Grid side)		
Input voltage range	180~270Vac	
Current(maximum continuous)	23.9A	
Frequency range	47-52Hz or 57-62Hz	

8. Specifications

Output AC(Grid side)		
Rated output power	3kW	3.6kW
Max. apparent output power	3.3kVA	4kVA
Maximum output fault current	17A	20A
Maximum output overcurrent protection	32A	
Operation phase	L-N-PE	
Rated grid voltage	220/230/240Vac	
Rating grid frequency	50/60Hz	
Rating grid output current	13A	15.7A
Max. output current	15.7A	17.3A
Output power factor	1 (default) and 0.8leading ... 0.8lagging adjustable	
THDi	<2%	
Efficiency		
Max efficiency of Solar Inverting	>97.5%	
European efficiency of Solar Inverting	>96.8%	
Max efficiency of Battery Inverting	>95%	
Max efficiency of Battery charging	>95%	
Protection		
Ground fault monitoring	Integrated	
Residual current monitoring unit	Integrated	
DC AFCI	Optional	
DC reverse polarity protection	Yes	
Protection class/Over voltage category	I/III	
General data		
Dimensions(W/H/D)	333*505*249mm	
Weight	17kg	
Operation temperature range	-25°C ~ 60°C	
Protection degree	IP65	
Inverter Topology	High frequency insulation (for battery)	
Relative humidity range	4% to 100%(condensing)	
Overvoltage category	II(PV)/III(MAINS)	
Pollution degree	PD 3	

8. Specifications

General data	
Noise emission (typical)	<20dBA
Cooling concept	Natural convection
Max.operation altitude	2000m
Design lifetime	>20 years
Grid connection standard	En50438, G83/2, G98, G99, G59/3, AS4777.2:2015, VDE0126-1-1, IEC61727, VDE N4105
Safety/EMC standard	IEC62040-1, IEC62109-1/-2, AS3100, , NB/T 32004, EN61000-6-1, EN61000-6-3
AC and DC Connections	Quick Connection
Display	7.0"LCD color screen display
Interface	CAN/RS485/WiFi/GPRS optional
Warranty	5 years standard (extend to 20 years)

8. Specifications

Technical Data	RHI-4.6K-48ES	RHI-5K-48ES
Input DC (PV side)		
Max. DC input power	6kw	6.5kw
Max power per MPPT	4kW	
The max DC input voltage	600Vdc	
Nominal DC voltage	330Vdc	
Start-up DC voltage	120Vdc	
MPPT operating voltage range	90-520V	
Full load MPPT voltage range	215-520V	234-520V
MPPT number/Max input strings number	2/2	
The rating max DC input current(A/B)	11A/11A	
Max short circuit current for each MPPT	17.2A/17.2A	
Max.inverter backfeed current to the array	0A	
Battery		
Battery Type	Li-ion	
Battery Voltage range	42 - 58Vdc	
Battery Capacity	50 - 2000Ah	
Maximum Charging Power	3000W	
Maximum Charge/discharge current	62.5A/62.5A	
Output AC(Back-up)		
Rating output power	3kW	
Transient max. apparent output power	4kVA, 10sec	
Back-up switch time	<10ms	
Operation phase	L-N-PE	
Rated grid voltage	220/230/240Vac	
Rated frequency	50/60Hz	
Rated output current	13A	
THDi	2%(linear load)	
Output AC (Grid side)		
Input voltage range	180~270Vac	
Current(maximum continuous)	23.9A	
Frequency range	47-52Hz or 57-62Hz	

8. Specifications

Output AC(Grid side)		
Rated output power	4.6kW	5kW(4.6kW for 4105)
Max. apparent output power	4.6kVA	5.5kVA(4.6kVA for 4105)
Maximum output fault current	26A	30A
Maximum output overcurrent protection	32A	
Operation phase	L-N-PE	
Rated grid voltage	220/230/240Vac	
Rating grid frequency	50/60Hz	
Rating grid output current	20.9A	21.7A
Max. output current	23A(21.7 for AUS)	23.9A(21.7 for AUS)
Output power factor	1 (default) and 0.8leading ... 0.8lagging adjustable	
THDi	<2%	
Efficiency		
Max efficiency of Solar Inverting	>97.5%	
European efficiency of Solar Inverting	>96.8%	
Max efficiency of Battery Inverting	>95%	
Max efficiency of Battery charging	>95%	
Protection		
Ground fault monitoring	Integrated	
Residual current monitoring unit	Integrated	
DC AFCI	Optional	
DC reverse polarity protection	Yes	
Protection class/Over voltage category	I/III	
General data		
Dimensions(W/H/D)	333*505*249mm	
Weight	17kg	
Operation temperature range	-25℃~60℃	
Protection degree	IP65	
Inverter Topology	High frequency insulation (for battery)	
Relative humidity range	4% to 100%(condensing)	
Overvoltage category	II(PV)/III(MAINS)	
Pollution degree	PD 3	

8. Specifications

General data	
Noise emission (typical)	<20dBA
Cooling concept	Natural convection
Max.operation altitude	2000m
Design lifetime	>20 years
Grid connection standard	En50438, G83/2, G98, G99, G59/3, AS4777.2:2015, VDE0126-1-1, IEC61727, VDE N4105
Safety/EMC standard	IEC62040-1, IEC62109-1/-2, AS3100, , NB/T 32004, EN61000-6-1, EN61000-6-3
AC and DC Connections	Quick Connection
Display	7.0"LCD color screen display
Interface	CAN/RS485/WiFi/GPRS optional
Warranty	5 years standard (extend to 20 years)

9. Appendix

9.1 Battery Terminal Assembly

In order to avoid DC arc, Solis suggest to install a DC switch between the battery and RHI inverter. (At least 65A)

- Make sure the polarities of battery is correct before connecting to the inverter;
- Please follow the instructions below to choose the battery power cable.



NOTE:

Power cable uses water-proofed AMPHENOL connectors. It must keep pressing this Lock Button during pulling out the power plug.

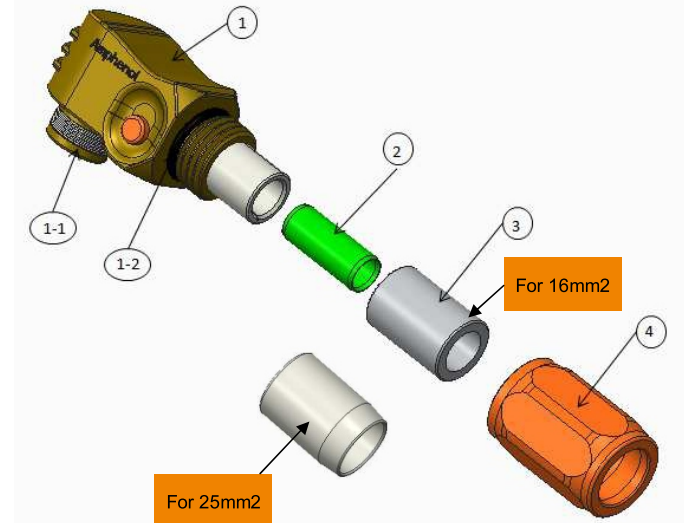

- ① : Connector Body
 - 1-1: Barrel sealing (Not included when no sealing requirement)
 - 1-2: O-Ring (Not included when no sealing requirement)
- ② : Barrel(Only for cable size 16mm²)
- ③ : Grommet(Not included when no sealing requirement)
- ④ : Back Shell

9. Appendix

Step 1: Wire cutting and stripping (Apply for 10mm² & 16mm² Cable)
Stripping conductor: 18±1mm

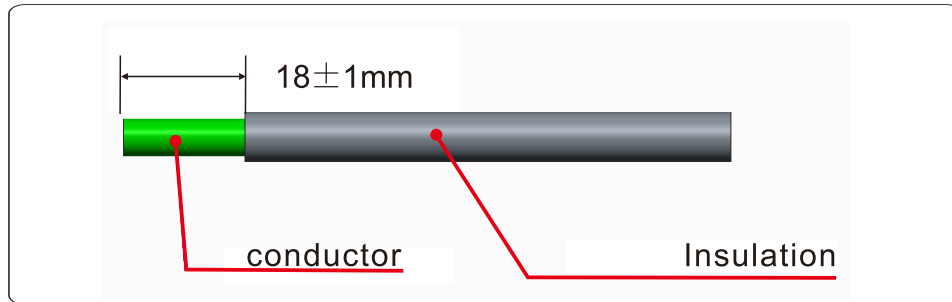

Step 2: Un-assemble item 3&4 over the cable as shown

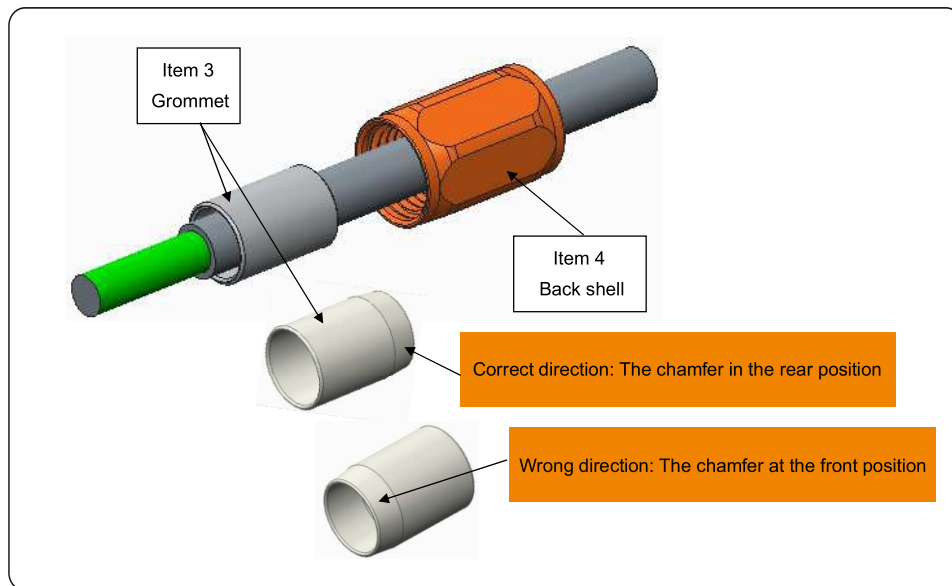

9. Appendix

Step 3: Put the barrel and the cable conductor into the lug

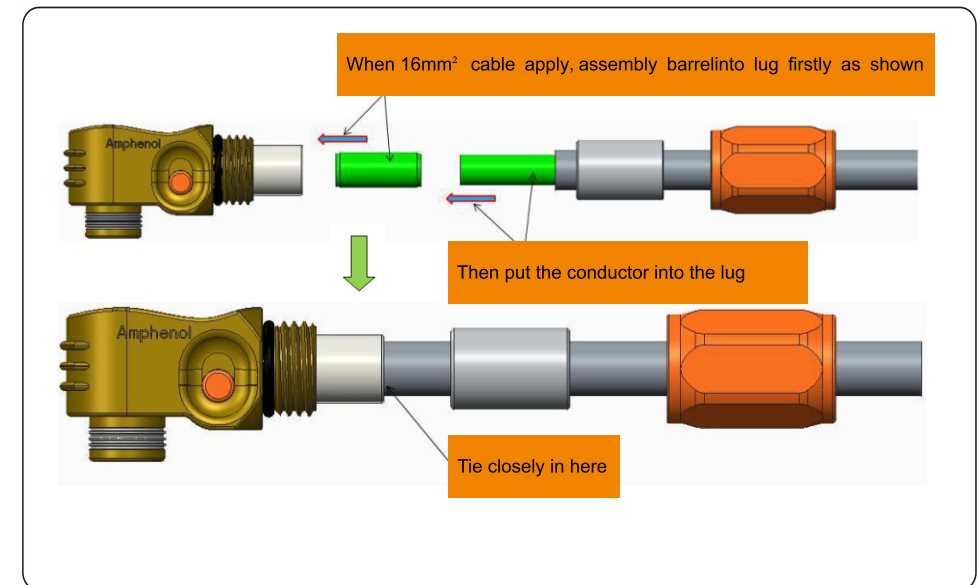

Step 4: Crimping the lug as shown

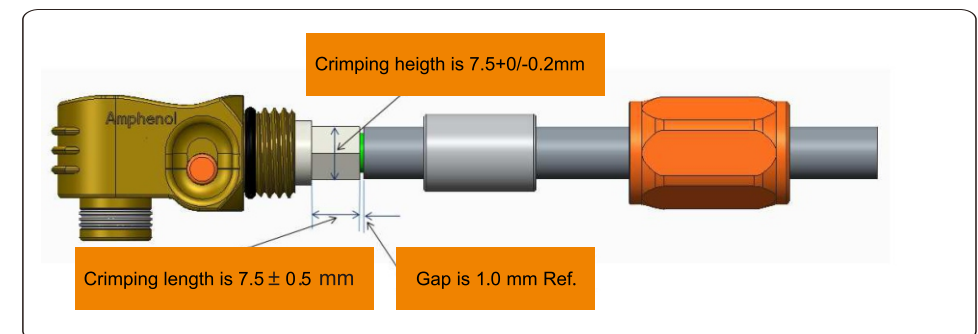

9. Appendix

9. Appendix

Cable size	Cable range	Crimping height	Cable pullout force
16 mm ²	8.10±0.20 mm	7.5+0/-0.2mm	1000N Min.
25 mm ²	10.20±0.20 mm		1200N Min.

Recommended crimping tool: Manual hydraulic crimping

Die: 25 mm²



Step 5: Install grommet and back shell

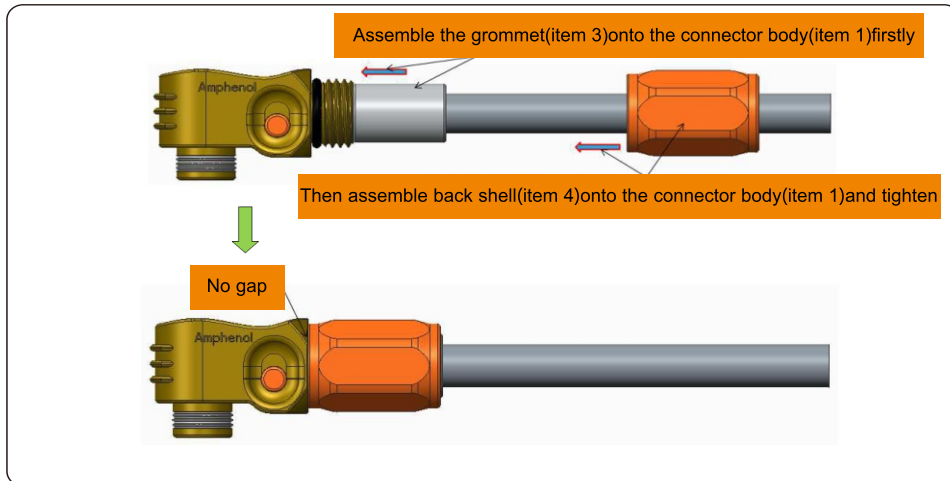

9.2 Three phase meter connection

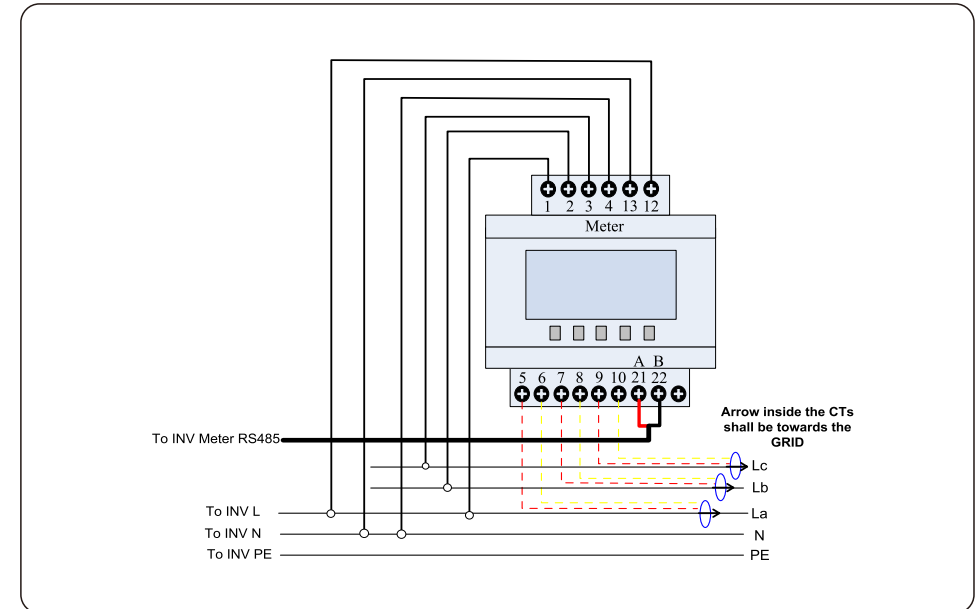

9.3 Special Back-up Connection

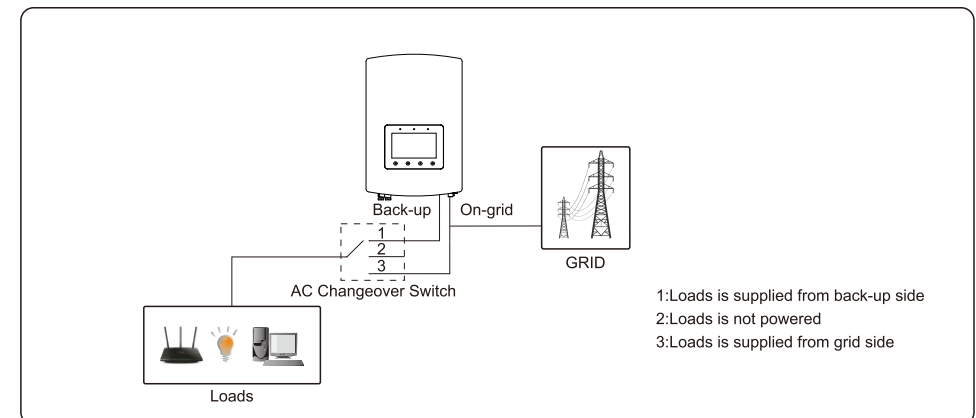

If need maintenance on RHI, then just switch AC Changeover Switch to position 3 as shown above. Thus the loads will be supplied by grid.

AC Changeover Switch is a 3rd party item not supplied by Ginlong.